

REAR VIEW OF V.D.U.
INVERTED

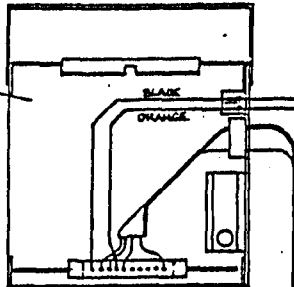

REAR VIEW OF COMPUTER
RACK - INVERTED

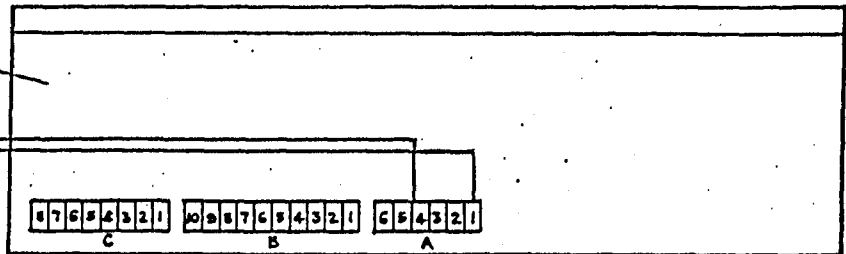

FOR MOTOROLA V.D.U.-PC1626
MOUNTED AS SHOWN. FOR PHILIPS
V.D.U. MOUNTED ON OPPOSITE SIDE.

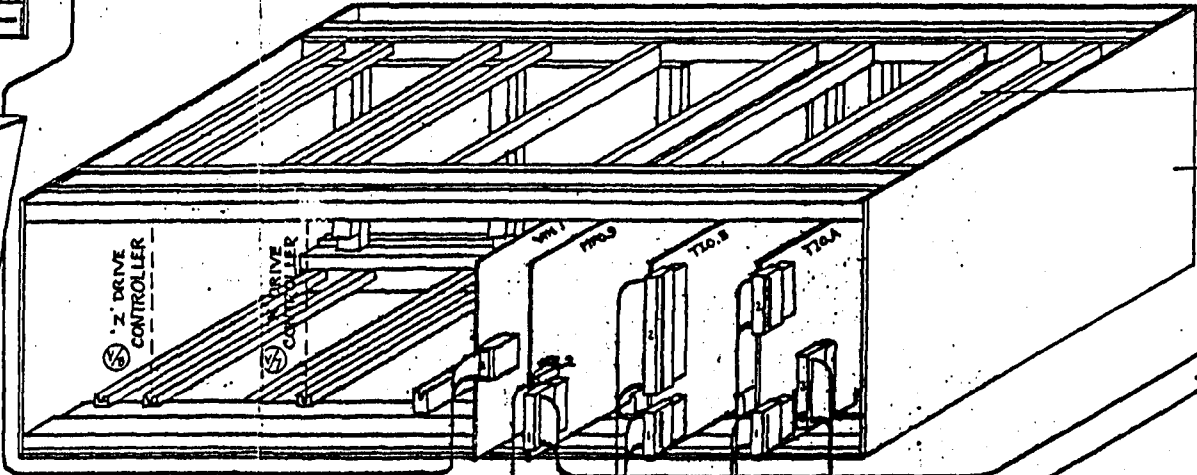
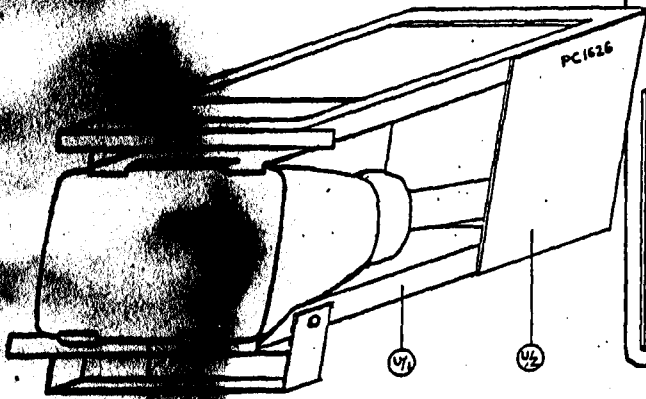

V_A

V_B

TO RS232
OUTPUT

TO PCL

TO RESET BUTTON

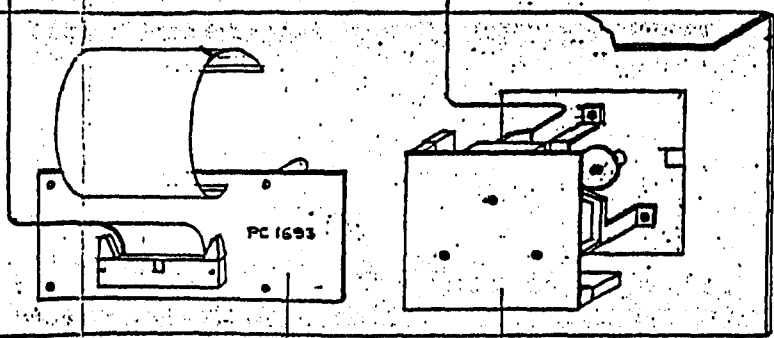
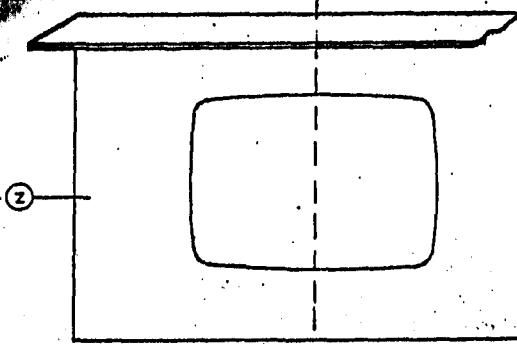

Z

Y

REVISIONS	RED. SCALE	JOB NO.	634 ELECTRICAL CONTROLS LTD. D.N.C. No. VICTORIA WORKS OLDFIELD HILL ROAD, HEDDERLEY, W. YORKS. POLAR GROUP LTD.	Dwg. No. L1723
TITLE	TRIBBON CABLE INTERCONNECTIONS	DATE		
		BY		
		CHECKED		

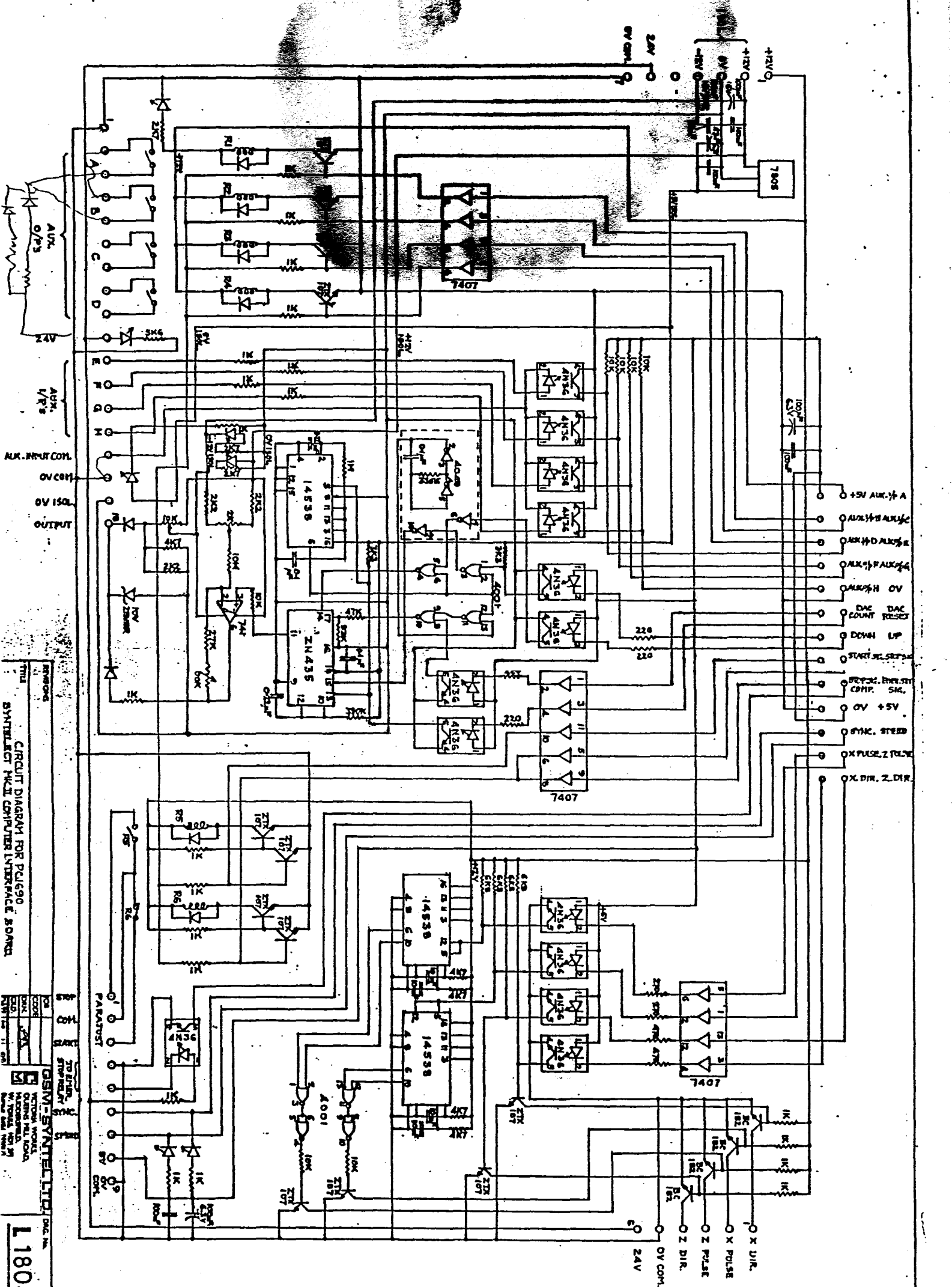

CIRCUIT DIAGRAM FOR PLS690
SYNTELLECT HWI COMPUTER INTERFACE BOARD

OSM-SYNTELLECT LTD. INC. TORONTO, CANADA
 11804

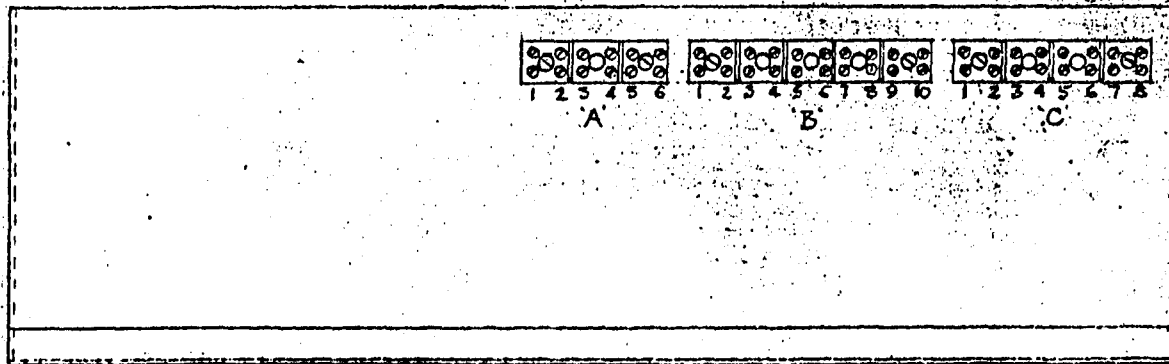
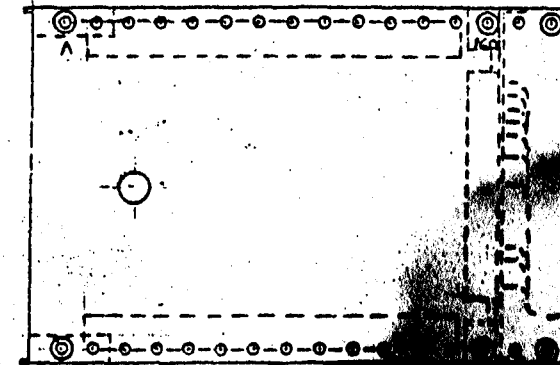
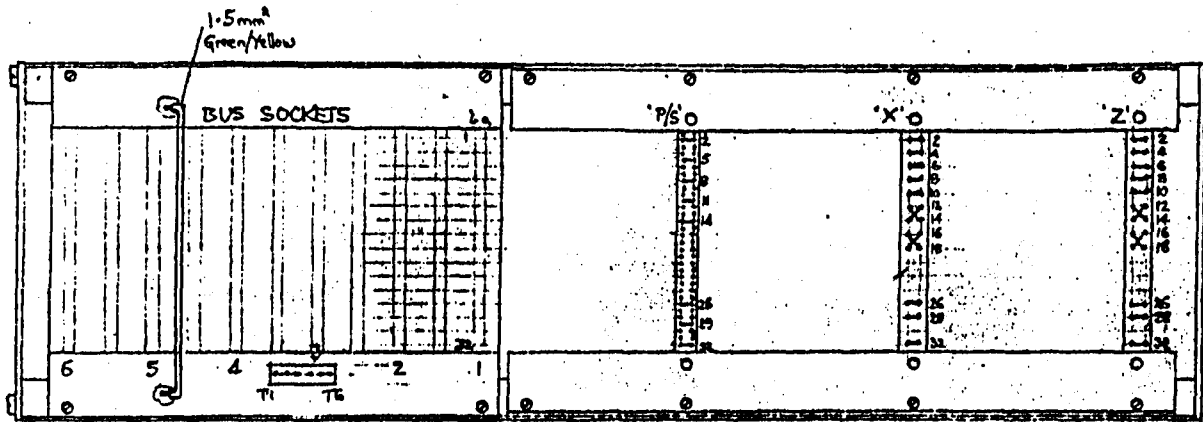

RACK CONNECTIONS

A1 - P/S5	(ORANGE 0.75)	B1 - Z1	RED 2 CORE SCREENED
P/S5 - BUS T3		B2 - Z2	BLUE
A2 - P/S2	(RED)	B3 - Z3	BLUE
P/S2 - BUS T6		B4 - Z4	
A3 - P/S11	(GREEN/YELLOW)	B5 - Z5	
P/S11 - P/S8		B6 - Z6	RED 0.75
A3 - SCREEN FROM 4 CORE BELOW		B6 - X1	
P/S8 - BUS T1	(GREEN/YELL 1.5)	B8 - X2	BLACK 1.5
P/S14 - BUS T4	(YELLOW 0.75)	B8 - Z32	
P/S32 - AA	(GREEN 4 CORE)	X32 - X16&18	
A5 - P/S23 a & b	(BLUE)	Z32 - Z16&18	
A6 - P/S25 a & b	(RED)	X16 - Z16	
C1 - Z4	(PURPLE 0.75)	B9 - Z12&14	RED
C2 - Z2	(BLUE)	B10 - X12&14	BROWN
C3 - Z6	(GREEN)		
C4 - Z8	(YELLOW)		
C5 - X4	(ORANGE)		
C6 - X2	(RED)		
C7 - X6	(BROWN)		
C8 - X8	(BLACK)		

BUS EACH LINK ACROSS MOTHER BOARD
ON X & Z, CUT OFF PINS 20, 22, 24, 30
CUT REMAINING PINS HALF-WAY DOWN
JOIN TOGETHER BOTH PINS AT 2, 4, 6, 8, 10, 26, 28
JOIN TOGETHER 4 PINS AT 12, 14 & 16, 18
AS SHOWN ABOVE

REVISIONS 2 WAY CHASSIS PLUG-T
ADDED - 10.8.83

HALF SCALE

JOB CODE
DAN J.S.
CKD.



GSM ELECTRICAL CONTROLS LTD.
QUEENS WORKS,
QUEENS HILL ROAD,
HUDDERSFIELD,
W. YORKS. HD1 3JH

DRG. No.
M1612

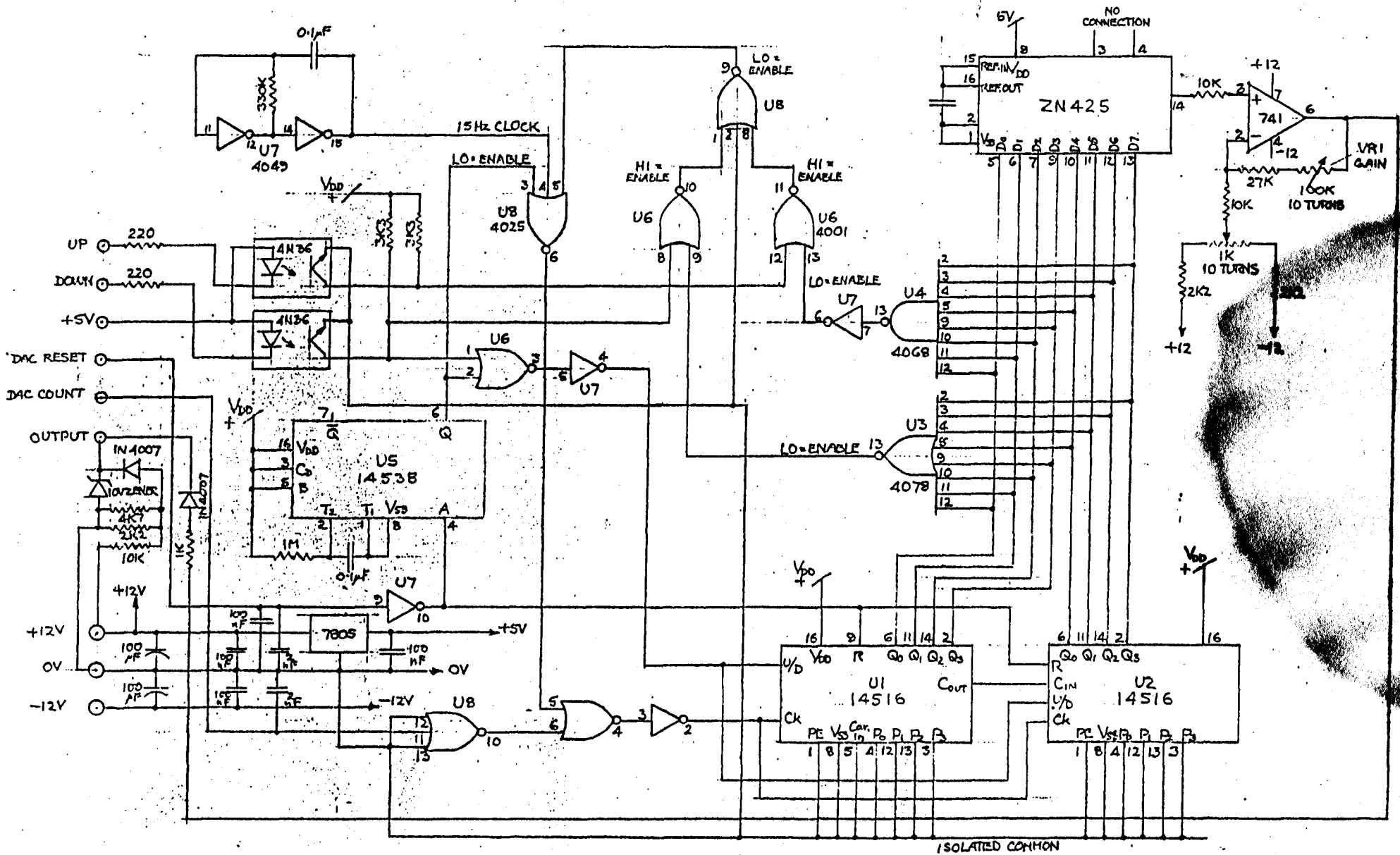

REVISIONS

TITLE

CIRCUIT DIAGRAM FOR 'ORAC' SPINDLE SPEED OVERRIDE BOARD - PC 1623

JOB	
CODE	
DRN.	J.S.
CKD.	

GSM ELECTRICAL CONTROLS LTD.
 VICTORIA WORKS,
 QUEENS HILL ROAD,
 HUDDERSFIELD,
 W. YORKS. HD1 3JF

DRG. No.
M 1667

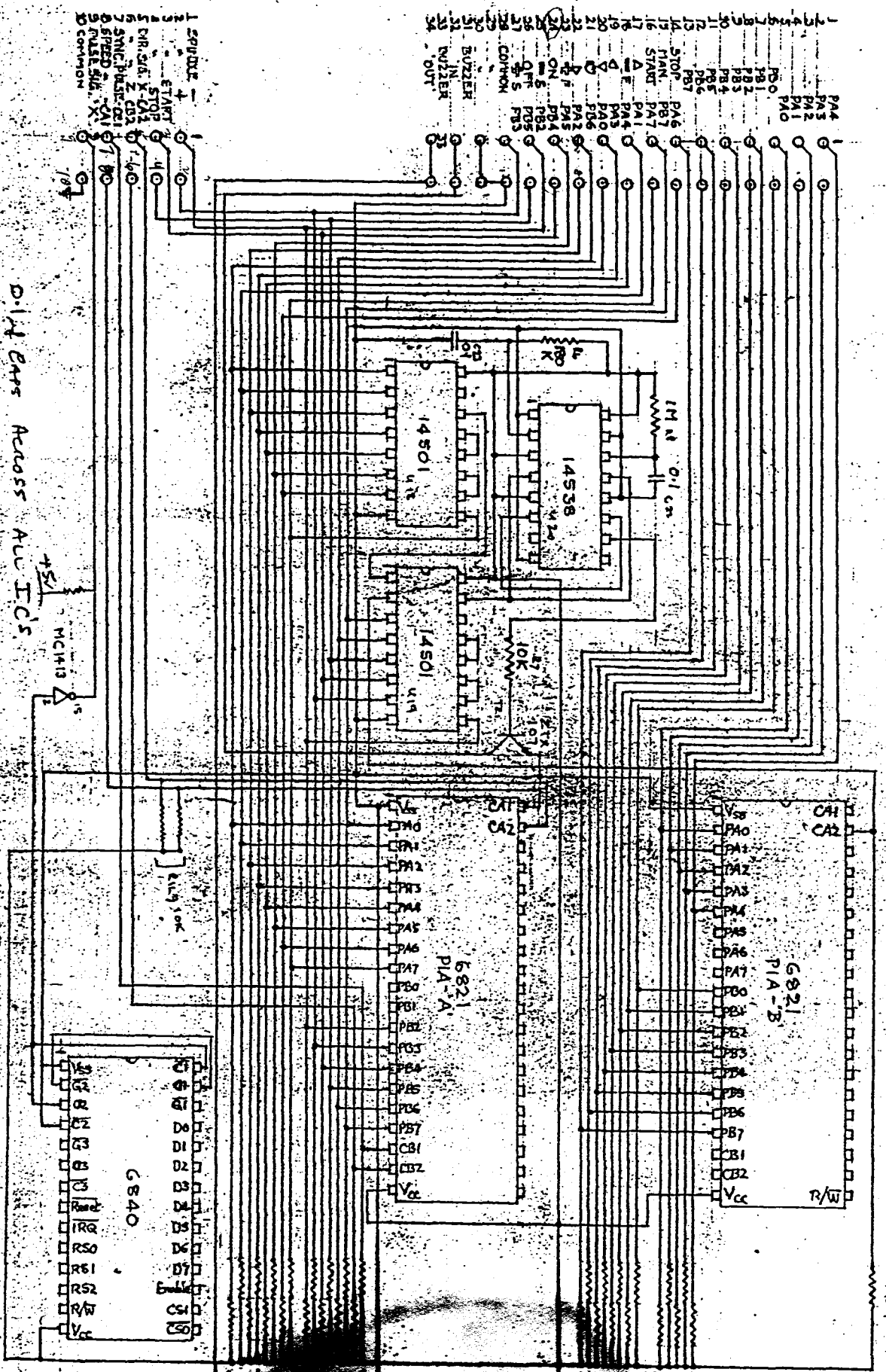

Diagrams Across All IC's

CIRCUIT DIAGRAM FOR MK2-TIO'B BOARD WITH R.F. P.F.R. ANTIDRAIVE

JOB	
CODE	
DNL	✓
CND	

GSM ELECTRICAL CONTROLS LTD.
 VICTORIA WORKS
 QUEEN'S HILL ROAD,
 HODDERSFIELD

DRG. No. **M1669**

REVISIONS

DATE

NOTE: C_{18} (and C_{19})
 1000 pF $\pm 10\%$ 16V. L_{25} 0.15H
 +0.1H. ACCESS +12V OUTPUT TO CASES

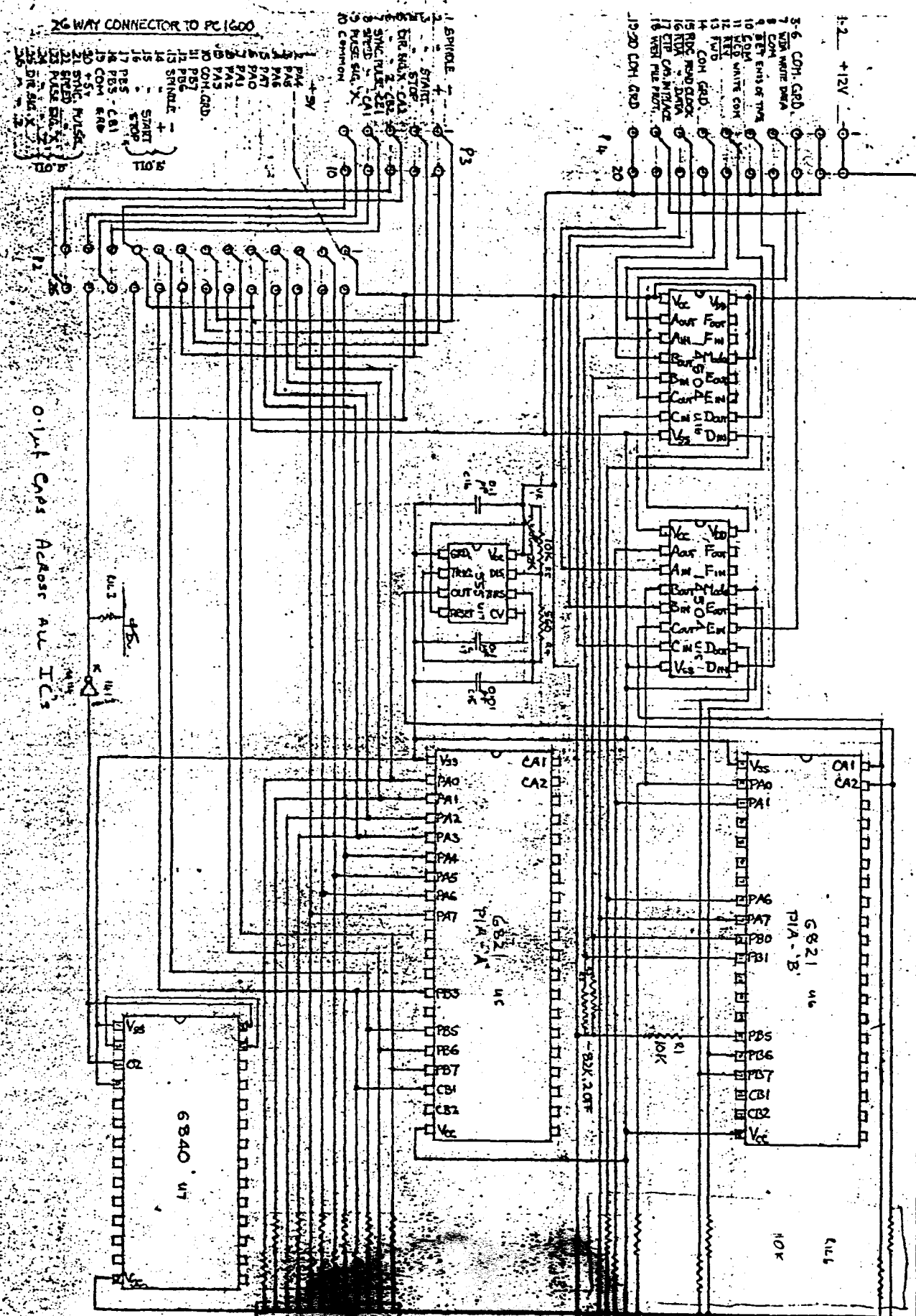

REVISIONS
 TITLE
 H 71

CIRCUIT DIAGRAM FOR MK2-TIO-A BOARD WITH CASSETTE INTERFACE

REV	DATE	BY	APP
1	10/1/73

GEM ELECTRICAL CONTROLS LTD.
 VICTORIA WORKS
 QUEEN'S HILL ROAD,
 HADDERSFIELD,
 W. YORKS. HD1 3JF
 PHONE 0484 3180/2

DRG. No. M 1670

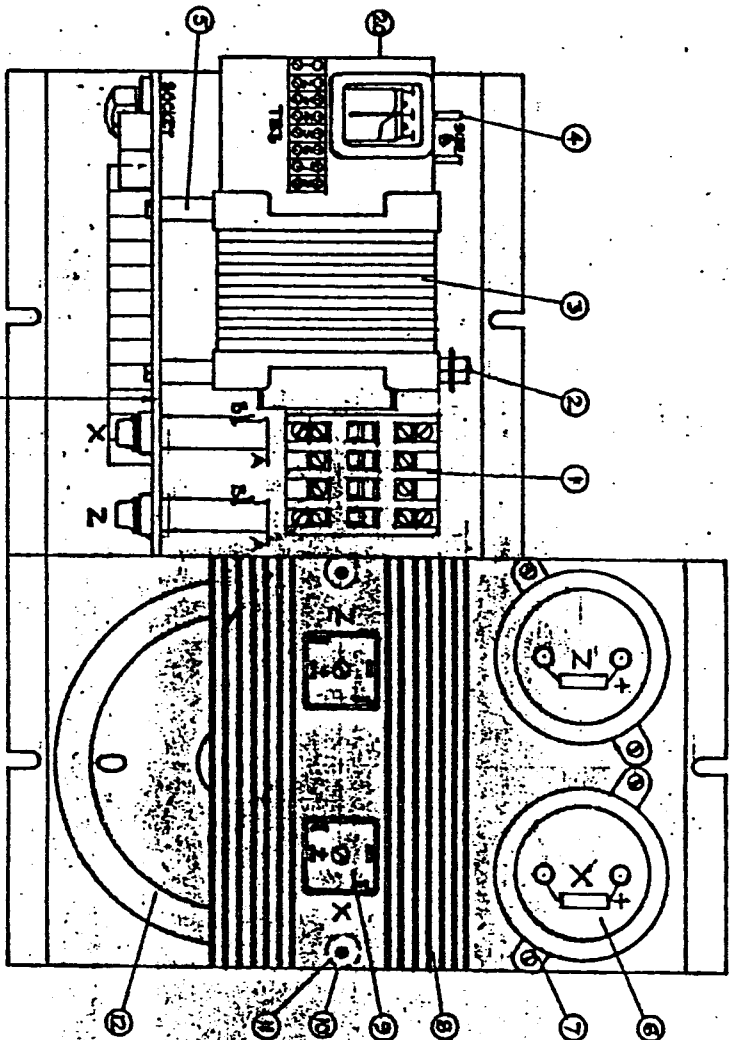

FOR DETAILS OF TRANSFORMER HOUSING PANEL, SEE ON RIGHT

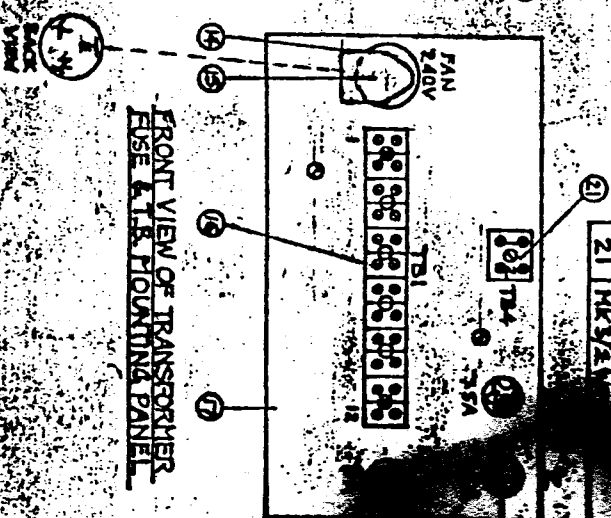

FRONT VIEW OF TRANSFORMER FUSE & FUSE MOUNTING PANEL

ITEM NO.	DESCRIPTION	QTY	UNIT
1	BRASS PLATE & SCREW	1	PCB126
2	2BAx78 EACH STUD	1	TM324
3	CONTROL TRANSFORMER	1	CH185
4	HAIR'S FILTER	1	CH174
5	4BAx78 BUS PILLARS	4	CH181
6	10000F/50VDC CAPACITOR	2	GH158
7	25 CAPACITOR CLIP	2	SA46
8	CM-1 HEADSTOCK	1	SR13
9	903 25F/50VDC RECTIFIER	2	
10	10BAx78 TUNE PILLARS	2	
11	25A SCREWED ROD	2	
12	1/2" SUPPLY POWER TRANSFORMER	1	TM316
13			
14	11436 BS SOCKET	1	
15	11436 AP PLUG	1	
16	MKT PLUG T...	1	
17	FUSE HOLDER	1	
18	FUSE HOLDER	1	
19	FUSE HOLDER	1	
20	FUSE	1	
21	MKT PLUG	1	

REVISIONS - FC 1619 ADDED, PAGES

RED. SCALE

43M ELECTRICAL CONTROLS LTD.

DRG. NO.

M1718

GENERAL ARRANGEMENT OF DRAC POWER SUPPLIES

FOR DETAILS OF TRANSFORMER HOUSING PANEL, SEE ON RIGHT

FRONT VIEW OF TRANSFORMER FUSE & FUSE MOUNTING PANEL

M1718

WIRING DIAGRAM FOR ORAC POWER SUPPLY

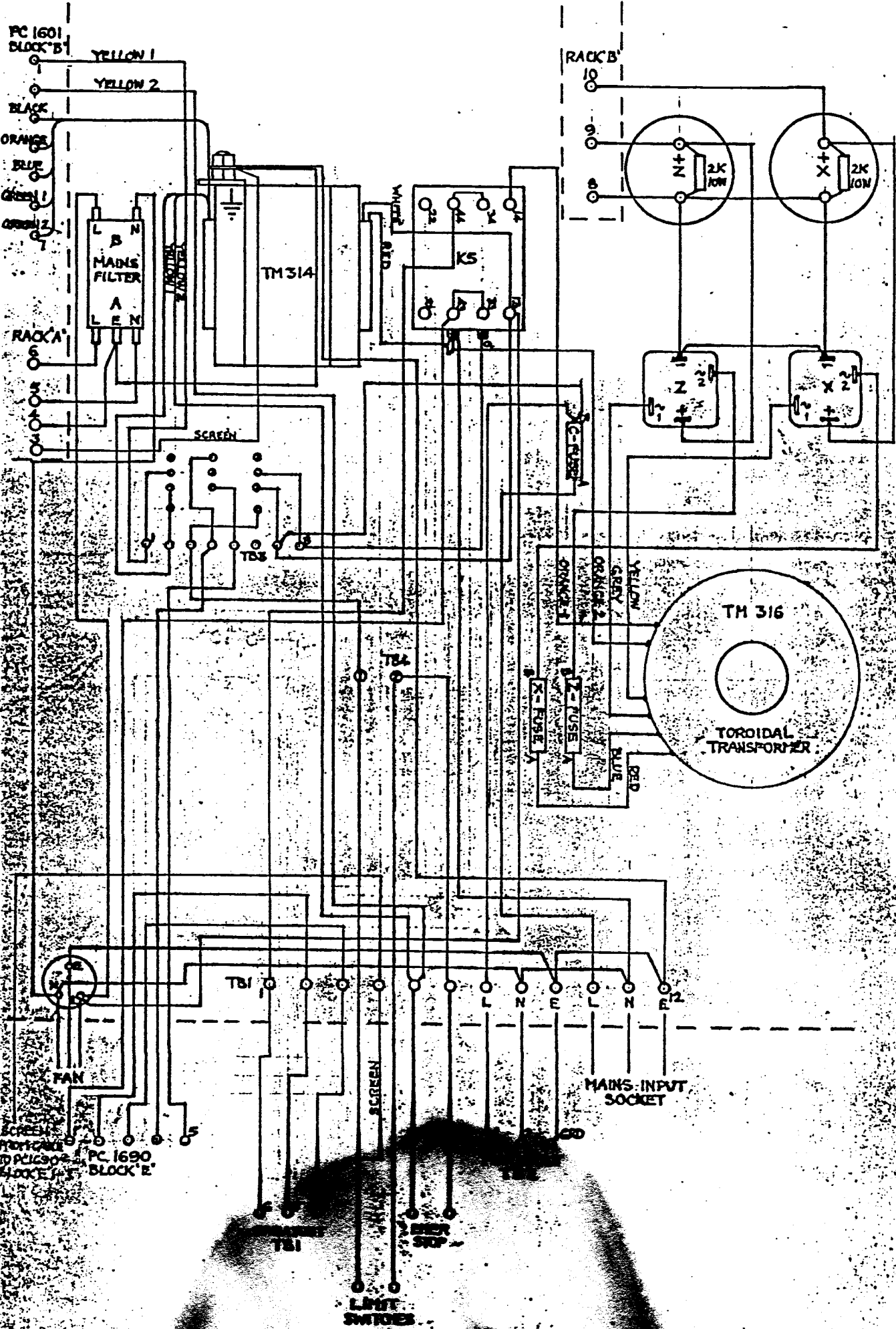

FOR	CODE	REV.
ORAC	275	1
ORAC		

IBM ELECTRONIC CONTROLS LTD.
 ACTON WORKS
 ACTON, MIDDLESEX
 ENGLAND

ORAC No. M1721

SEE ORG. 3 FOR CIRCUIT DIAGRAM.

NOTE
 C7 HAS A 15G/V EARTH LEAD FROM P.S.U.
 C1 HAS AN ORANGE LEAD FROM INSP. LAMP
 A3 HAS A RED LEAD FROM CASSETTE.

D1 - RED } 2 CORE SCREENED
 D2 - BLUE }
 D3 - BLUE } 2 CORE SCREENED
 D4 - RED }
 D5 - BOTH SCREENS FROM ABOVE
 D6 - RED 0-75.

- BLACK 0-75 - C1
- C2
- C3
- C4
- C5
- C6
- C7
- A1 - C6
- A2 - C7
- A3 - C1
- A4 - C2
- A5 - C3
- A6 - C3
- A7 - C4

- D1 - BLACK BOTTOM
- D2 - B2
- D3 - B3
- D4 - B4
- D5 - B6
- D6 - B6

- B1 - YELLOW
- B2 - YELLOW WIRE
- B3 - BLACK PROTECT
- B4 - ORANGE ON COVER
- B5 - BLUE SUPPLY
- B6 - GREEN CHASSIS
- B7 - GREEN

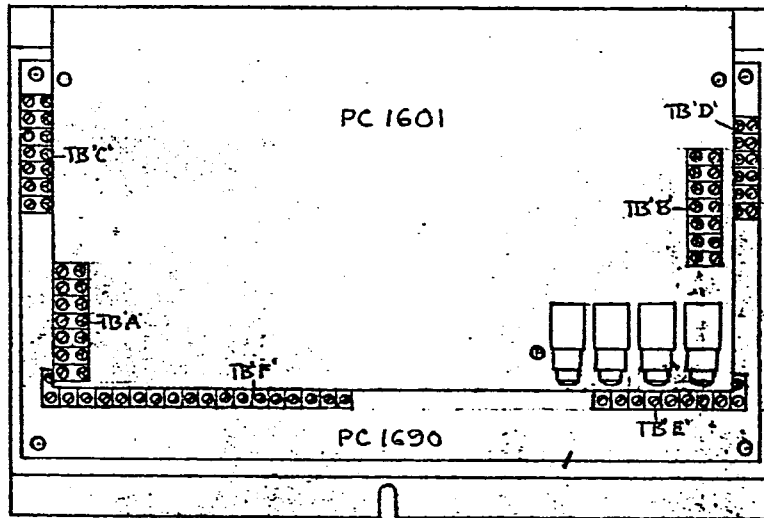

- 1 - COMMON:
- 2
- 3
- 4
- 5
- 6
- 7
- 8
- 9
- 10
- 11
- 12
- 13
- 14
- 15
- 16
- 18 - P/Inst. TB/2 (R) } 4 CORE
- 17 - TB/1 (C) } SCREENED
- 9 - PC1685 TB/1 (A, S)
- 8 - PC1685 TB/2 (R)
- 7 - PC1685 TB/3 (S)
- 6 - PC1685 TB/4 (Y)
- 5 - P.S.U. TB3/5
- 4 - P.S.U. TB3/4
- 3 - P.S.U. TB/3 } 4 CORE
- 2 - P.S.U. TB/2 } SCREENED (Y)
- 1 - P.S.U. C 43 } DYNAMISU (R)

4 CORE SCREENED
 TO SENSOR BOARD
 PC 1685

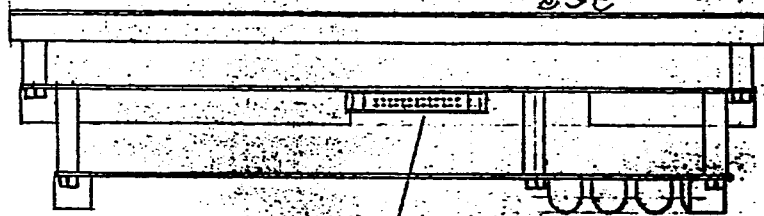

CABLE TO

160 - 1690 LAYOUT
 160 - 1690

REVISIONS
 TITLE
 GENERAL ARRANGEMENT AND CONNECTIONS FOR PC1690 & PC1601
 DRAWN BY: M. J. HARRIS

JOB	COOR
D.M.	J.S.
CRD.	

GSM ELECTRICAL CONTROLS LTD.
 VICTORIA WORKS
 QUEENS HILL ROAD,
 HUNDERSFIELD,
 W. YORKS. HD1 1JG

DRG. No.
M 1739

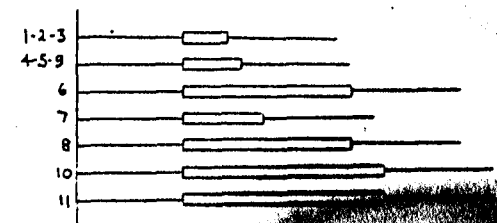
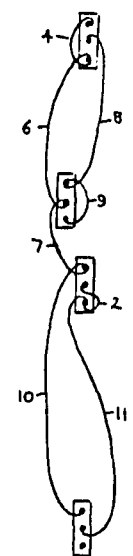
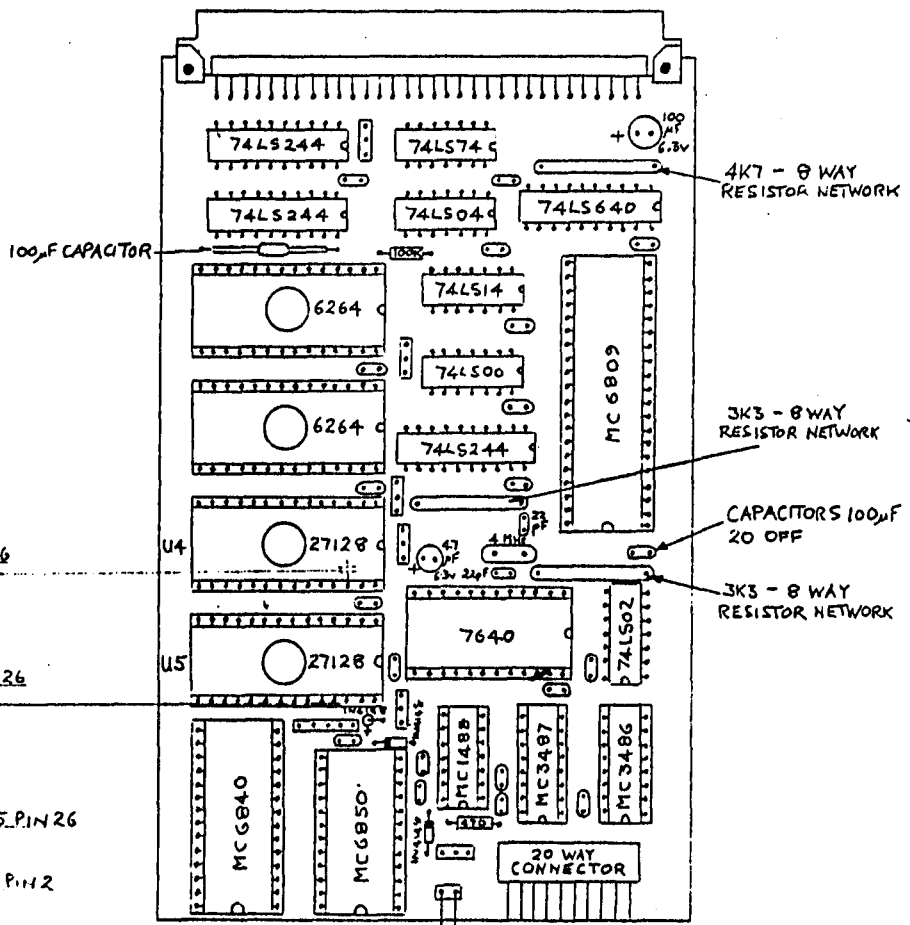

1,2,3,8,11 ARE BLUE
4,5,6,7,9,10 ARE RED

DETAILS OF WIRE WRAP LINKS ON PCB CONNECTION PINS

REVISIONS

TITLE

COMPONENT LAYOUT FOR MP09 CARD FOR ORAC MK III

JOB	
CODE	
DRN.	A C H.
CKD.	



GSM ELECTRICAL CONTROLS LTD.
VICTORIA WORKS,
QUEENS MILL ROAD,
HUDDERSFIELD,
W. YORKS. HD1 3PJ

DRG. No.

M1768

TYPE MR-25 RESISTOR - 130K
0.22µF CAPACITOR - WITH 10%

A-6N1375 CHANGED TO
4N365. OLD PINS 1 & 8 NOT
USED, PIN 6 ON 4N36-N.C.

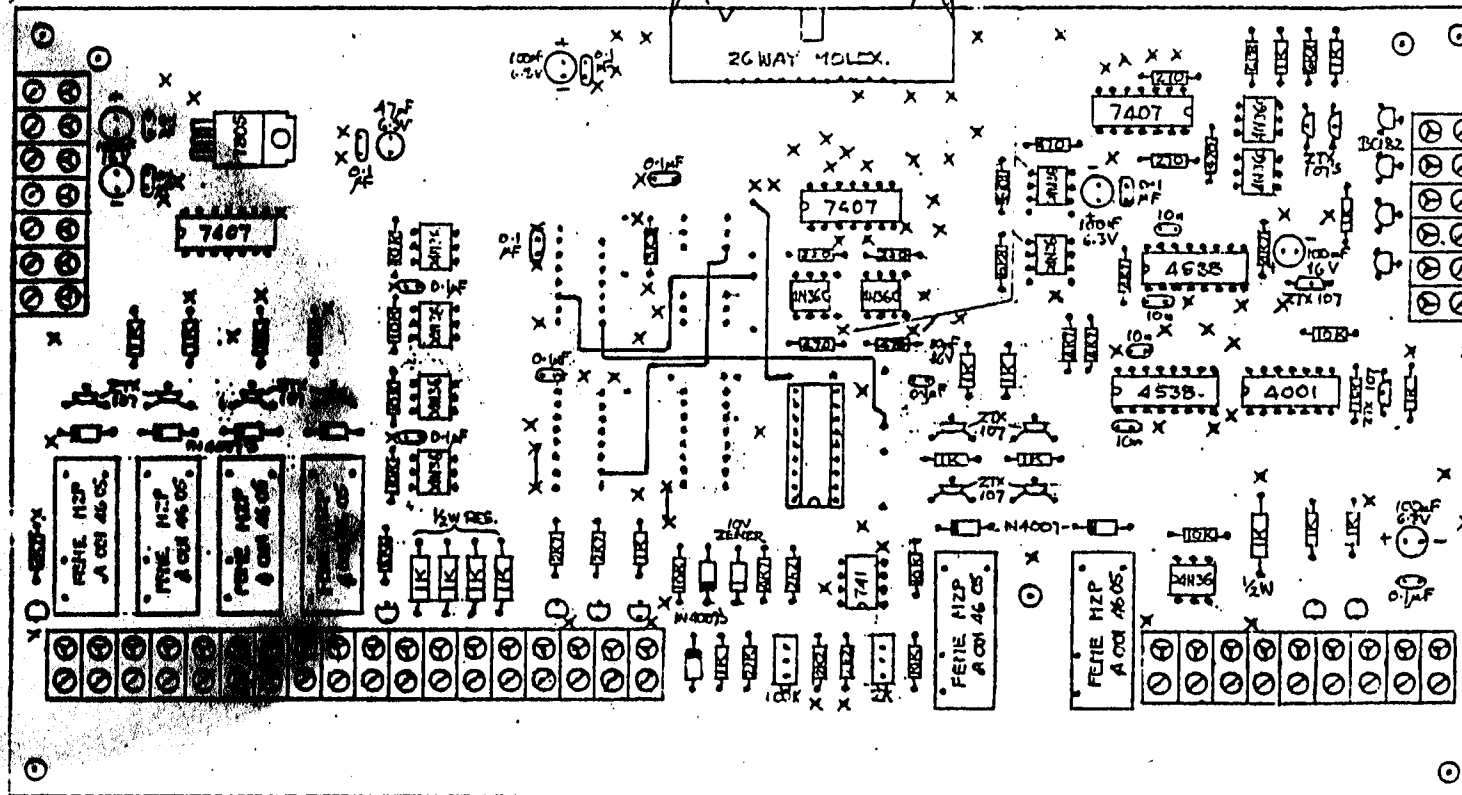

LINK WIRES TO BE FITTED AS SHOWN

1 2 3 - 1CM RE-40LD OR SILVER HEAD			
COLOUR CODE			
RESISTOR VALUE	BAND 1	BAND 2	BAND 3
270	R	V	BR
470	Y	V	BR
1K	BR	BK	R
2K2	R	R	R
2K7	R	Y	R
3K3	O	O	R
4K7	Y	V	R
5K6	G	BL	R
6K8	BL	GY	R
10K	BR	BK	O
27K	R	V	O
47K	Y	V	O
82K	GY	R	O

THIS BOARD USED IN CONJUNCTION
WITH MODIFIED PC 1623 - SEE M.1849

REVISIONS VARIOUS DELETIONS & ALTERATIONS
TO BOARD. 30. 8. 83 & 9. 2. 84

TITLE

COMPONENT LAYOUT FOR MODIFIED PC 1690
SYNTELLECT MKII COMPUTER INTERFACE BOARD

JOB
CODE
DWN. *J.B.*
CKD.

GSM-SYNTTEL LTD.
VICTORIA WORKS,
QUEENS MILL ROAD,
HUDDERSFIELD,
W. YORKS. T12 9PL

DRG. No.

M1848

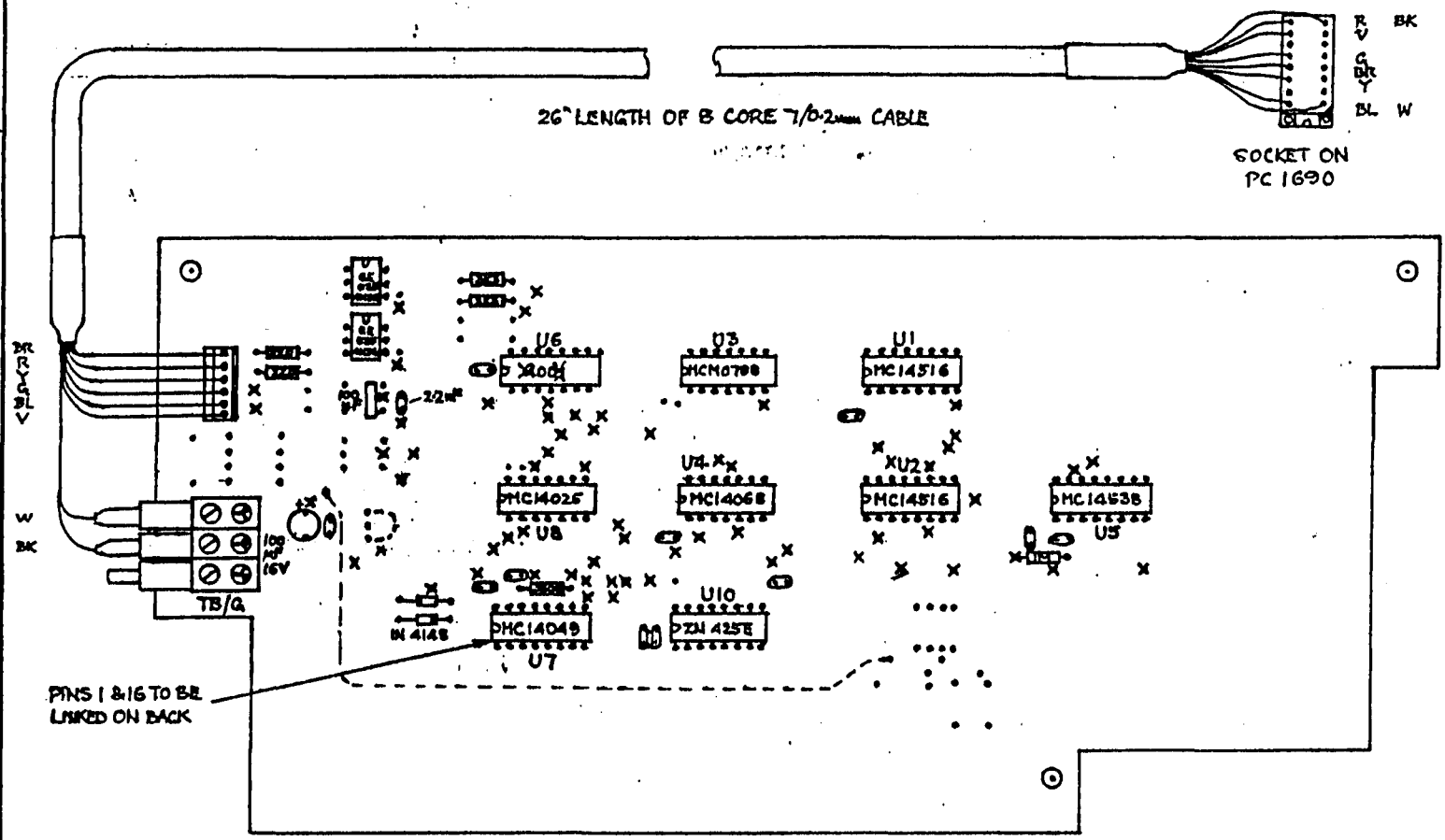

○ - 100nF CAPACITORS UNLESS MARKED OTHERWISE.
 x - THROUGH BOARD CONNECTING PINS.
 ALL RESISTORS 1/4W, 5% TOLERANCE.
 BACK OF BOARD CABLE LINKS SHOWN DOTTED.

THIS VERSION USED ONLY WITH MODIFIED PC 1690 - SEE M. N.

COLOUR CODE	
RESISTOR VALUE	RESISTOR VALUE
330	R R
33K	O O
330K	O O Y
1M	BR BK G

REVISIONS	
TITLE	COMPONENT LAYOUT FOR MODIFIED PC 1623 ORAC SPINDLE SPEED OVERRIDE BOARD.

JOB	
CODE	
DRN.	YB
CKD.	
DATE	9.2.84

GSM ELECTRICAL CONTROLS LTD.
 VICTORIA WORKS,
 QUEENS HILL ROAD,
 HUDDERSFIELD,
 W. YORKS. HD1 3PJ
 PHONE 0484 351012

DRG. No.
M1849

NOTE! THIS SIDE IS THE TRACK SIDE

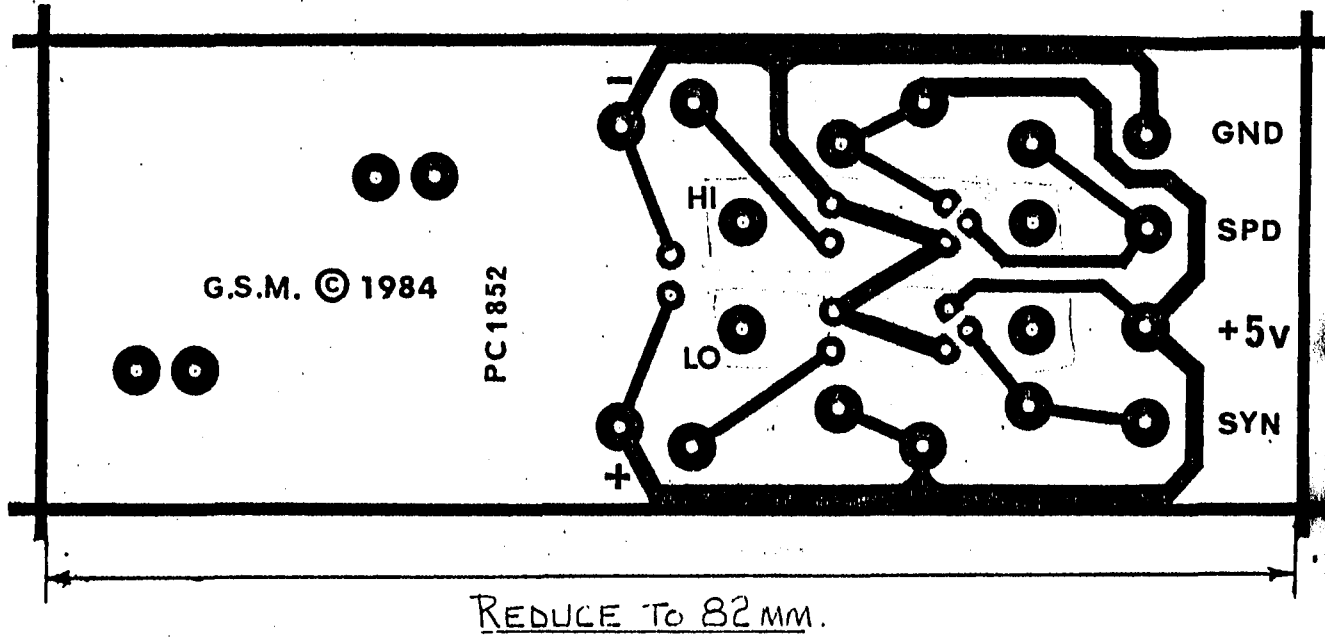

FOR DRILLING DETAILS SEE S1853.

MATERIAL: $\frac{3}{32}$ " GLASS FIBRE BOARD.

SCALE: TWICE FULL-SIZE.

REVISIONS REDRAWN FROM PC1752 TO INCLUDE 2x1K-0.04M. PULL-UP RESISTORS & 100nF CAPACITOR.

TITLE SYNTELECT MK III OPTO SENSOR P.C.B. (AXIAL MOUNT).

JOB	
CODE	
DRN.	PRB
CKD.	
DATE	20.2.84

GSM-SYNTTEL LTD.
 VICTORIA WORKS,
 GUERNS MILL ROAD,
 HUDDERSFIELD,
 W. YORKS. HD1 3PG
 Phone: 0484 35101/2

DRG. No.

PC1852

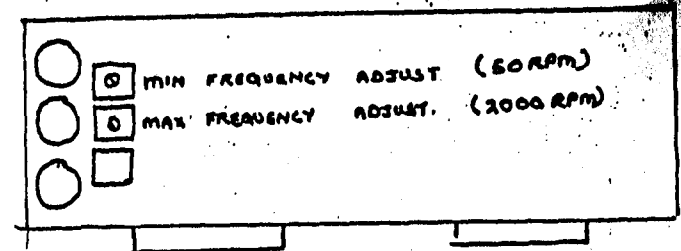
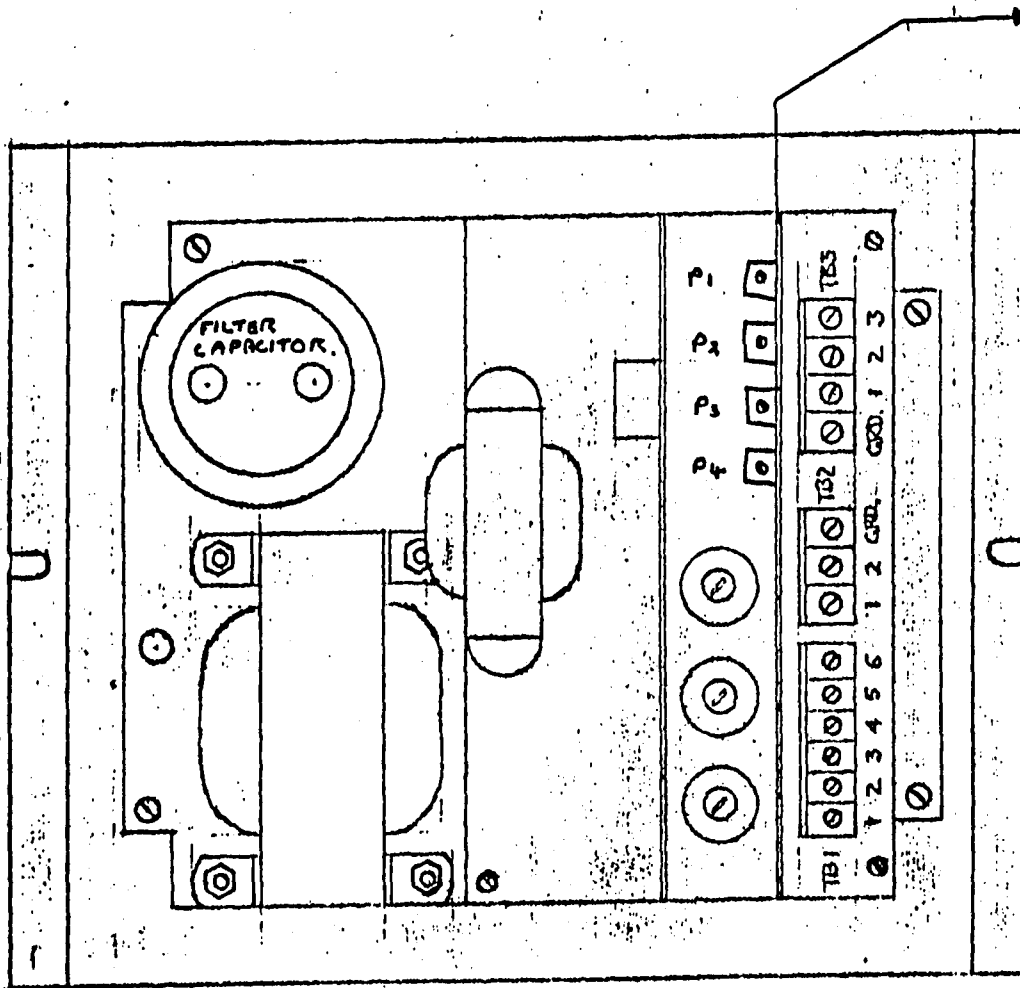

REVISIONS PARAJUST UNIT TURNED
 ON CHASSIS-10.8.83

HALF SCALE

JOB	
CODE	
DRN.	J.B.
CKD.	
DATE	7.8.82.

GSM ELECTRICAL CONTROLS LTD.
 VICTORIA WORKS,
 QUEENS MILL ROAD,
 HUDDERSFIELD.
 W. YORKS. HD1 3PJ
 PHONE 0484 35101/2

DRG. No.

S 1609

TITLE
 GENERAL ARRANGEMENT OF FHP PARAJUST.
 'ORAC' CHASSIS.

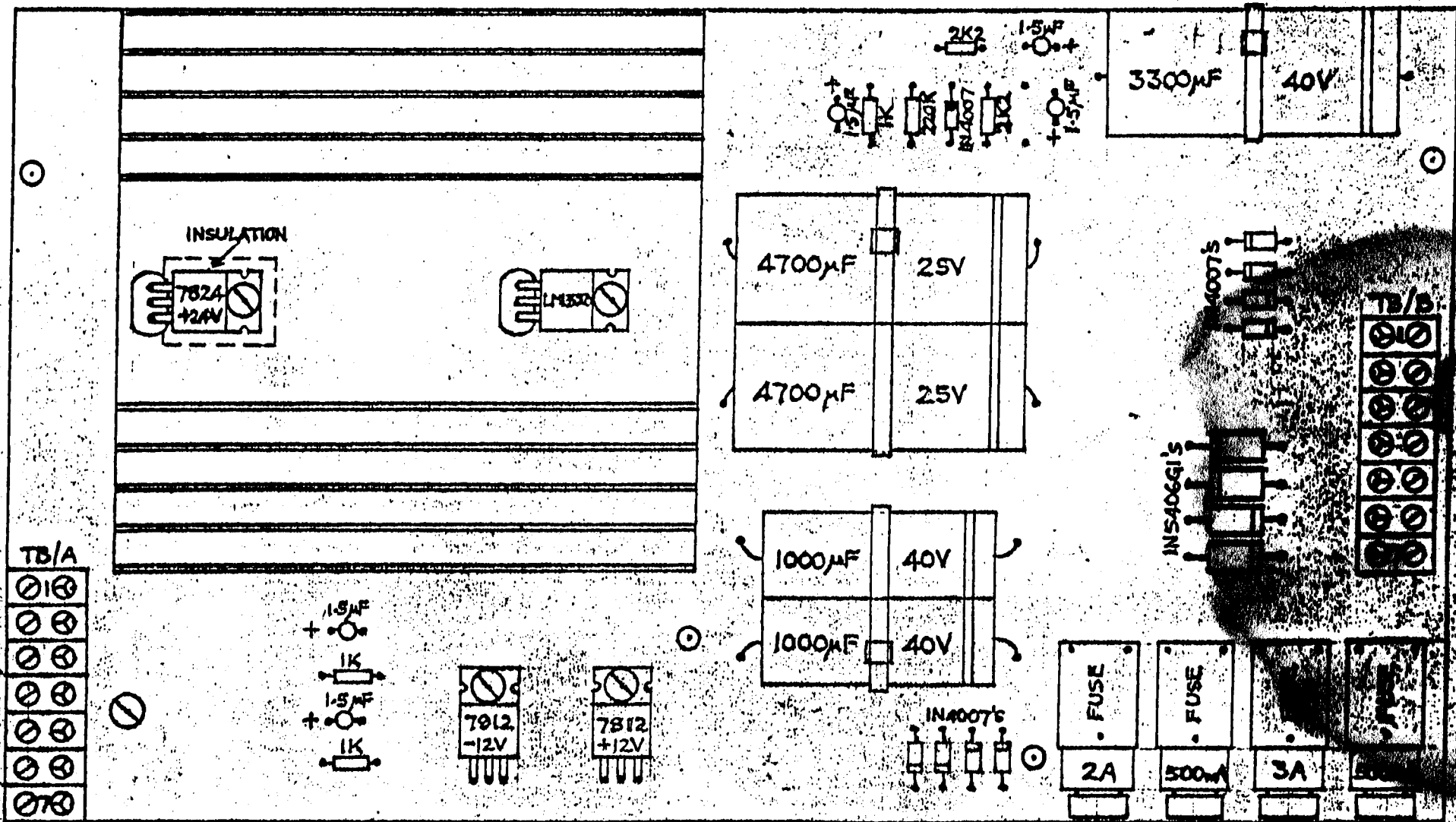

REVISIONS - 14V SUPPLY REMOVED
22. 11. 82.

TITLE

COMPONENT LAYOUT FOR PC 16011
COMPUTER P.S.U. ON 'ORAC' MACHINE.

JOB	
CODE	
DRN.	J.P.
CKD.	
DATE	7 9 82



GSM ELECTRICAL CONTROLS LTD.
VICTORIA WORKS,
QUEENS MILL ROAD,
HUDDERSFIELD,
W. YORKS. HD1 3PJ
PHONE 0484 35101/2

DRG. No.

S 1610

CABLE SUPPLIED
WITH SHARP
CASSETTE

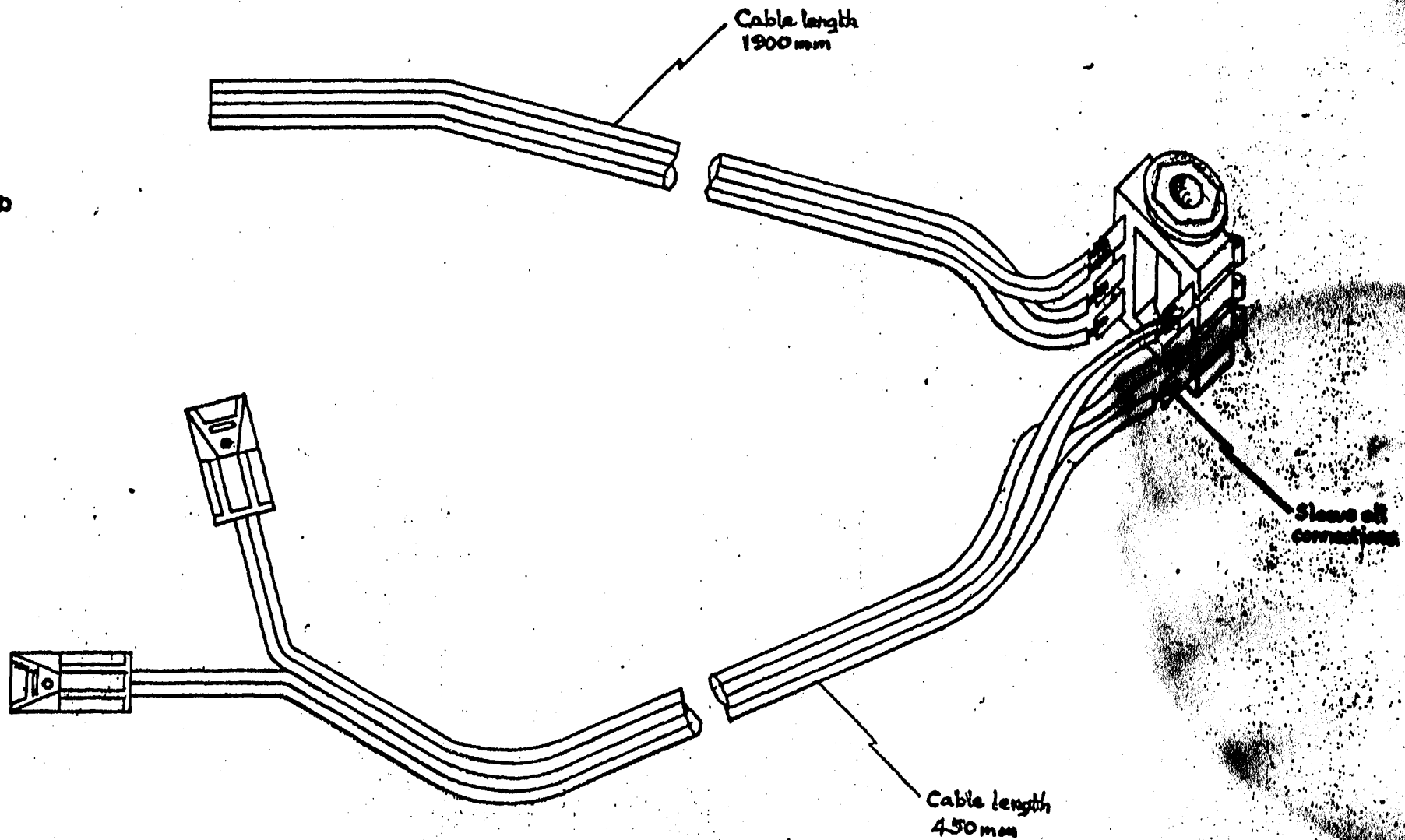

REVISIONS

TITLE
JACK SOCKET CONNECTION DETAILS

JOB	
CODE	
DRN.	A. C. M.
CKD.	
DATE	18.11.82

GSM ELECTRICAL CONTROLS LTD.

 VICTORIA WORKS,
 QUEENS MILL ROAD,
 HUDDERSFIELD.
 W. YORKS. HD1 3PJ
 PHONE 0484 351012

DRG. No.
S1632

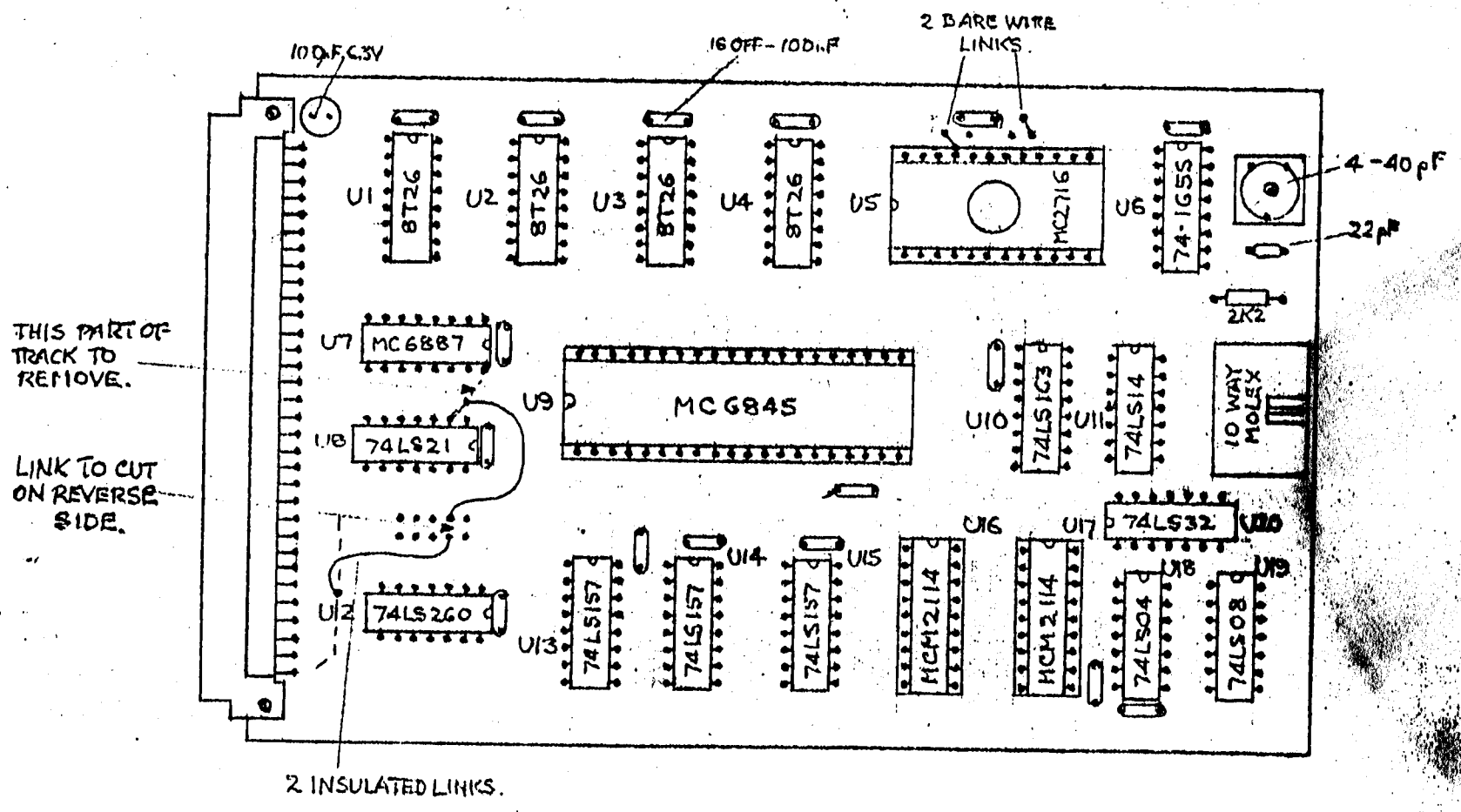

REVISIONS	JOB	G M GSM ELECTRICAL CONTROLS LTD. VICTORIA WORKS, QUEENS MILL ROAD, HUDDERSFIELD, W. YORKS. HD1 3PJ PHONE 0484 35101/2	DRG. No. S1639
TITLE	CODE		
COMPONENT LAYOUT FOR V.I.H.I. CARD.	DRN. <i>P.93.</i>		
	CKD.		
	DATE <i>G. 12.87.</i>		

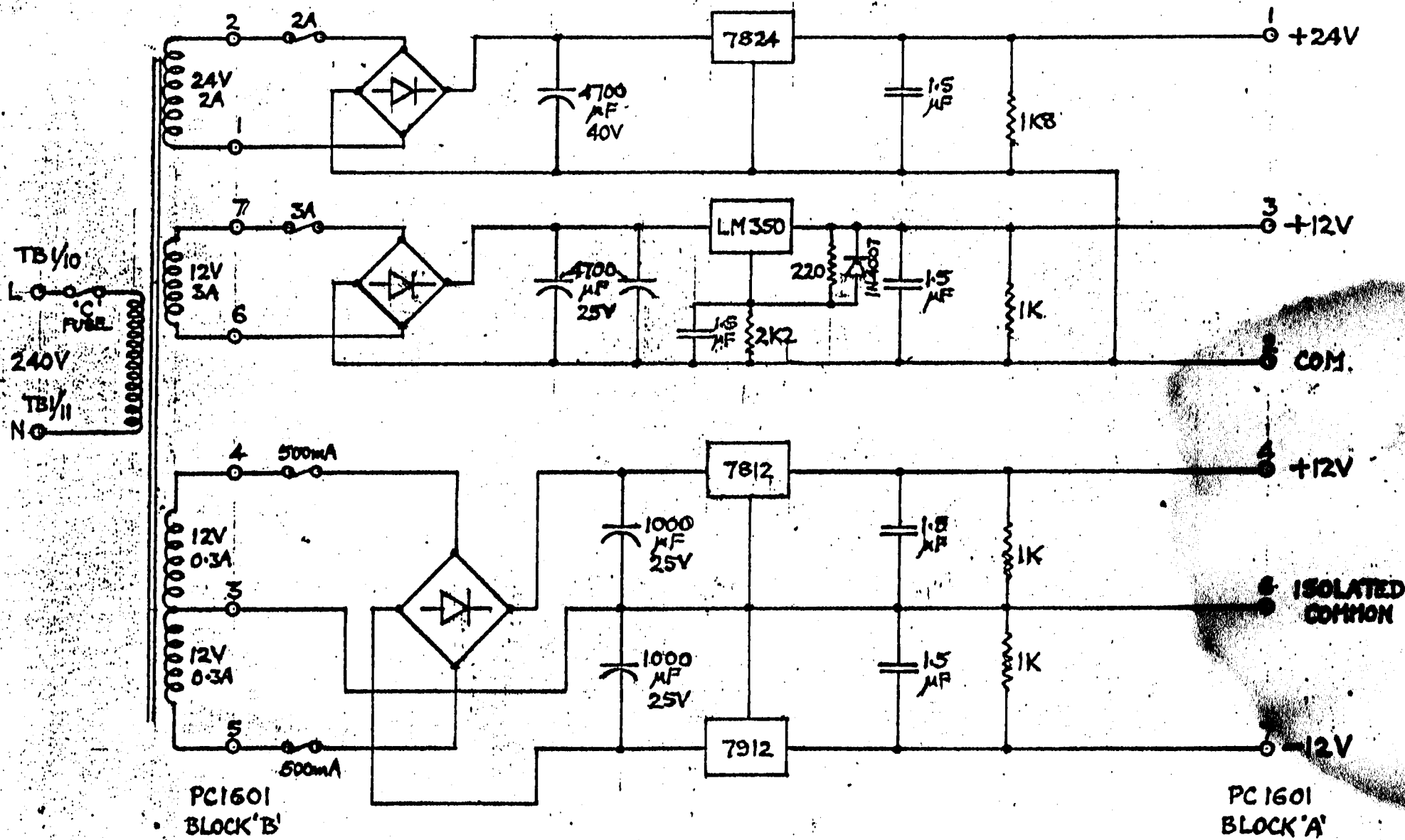

REVISIONS

TITLE

CIRCUIT DIAGRAM FOR PC 1601
'ORAC' POWER SUPPLY REGULATOR BOARD

JOB	
CODE	
DRN.	J.B.
CKD.	
DATE	22. 12. 82



GSM ELECTRICAL CONTROLS LTD.
VICTORIA WORKS,
QUEENS MILL ROAD,
HUDDERSFIELD.
W. YORKS. HD1 3PJ
PHONE 0484 35101/2

DRG. No.

S 1645

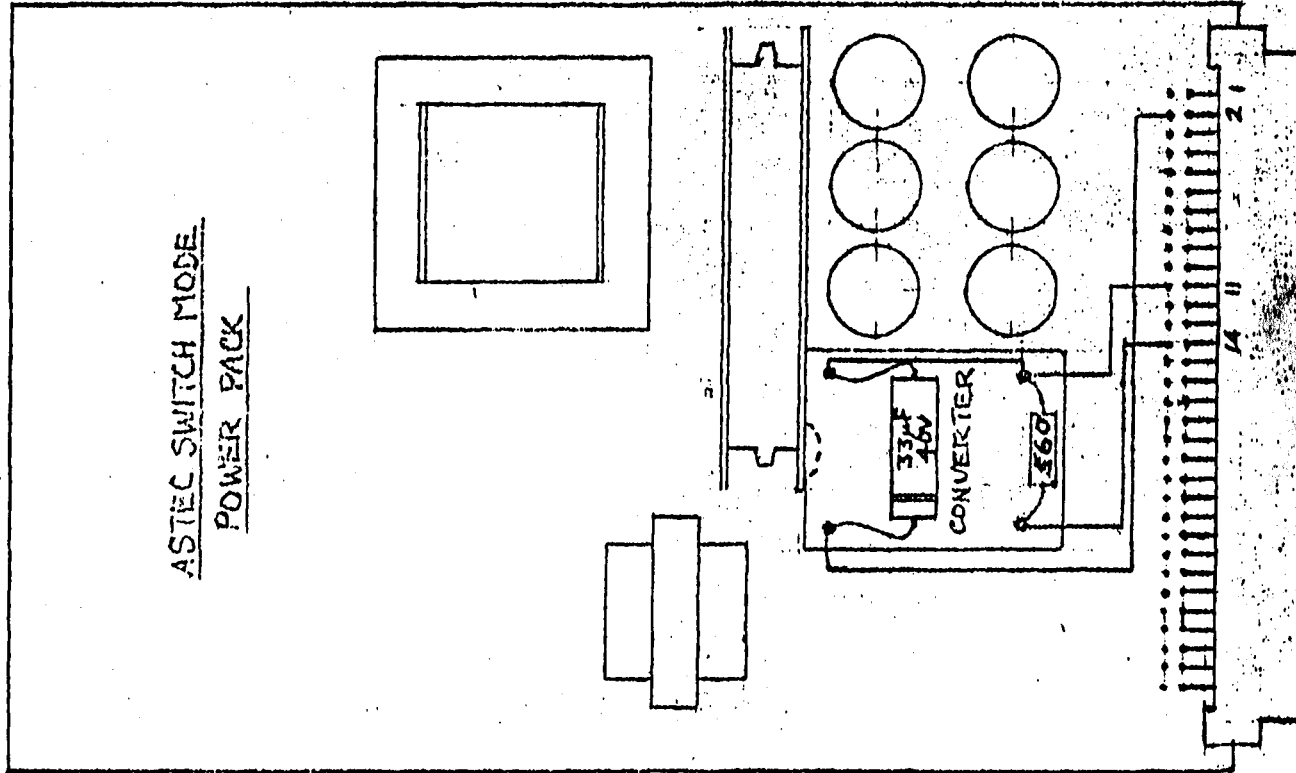

ASTEC SWITCH MODE
POWER PACK

TIPY TO -12V CONVERTER
MOUNTED ON HEAT SINK
WITH SUPERGLUE

REVISIONS

TITLE

DETAIL OF -12V CONVERTER MOUNTING & CONNECTIONS
TO ASTEC POWER PACK FOR 'ORAC' MACHINE.

JOB	
CODE	
DRN.	<i>LFB</i>
CKD.	
DATE	<i>10. 1. 85</i>



GSM ELECTRICAL CONTROLS LTD.
VICTORIA WORKS,
QUEENS MILL ROAD,
HUDDERSFIELD.
W. YORKS. HD1 3PJ
PHONE 0484 35101/2

DRG. No.

S 1649

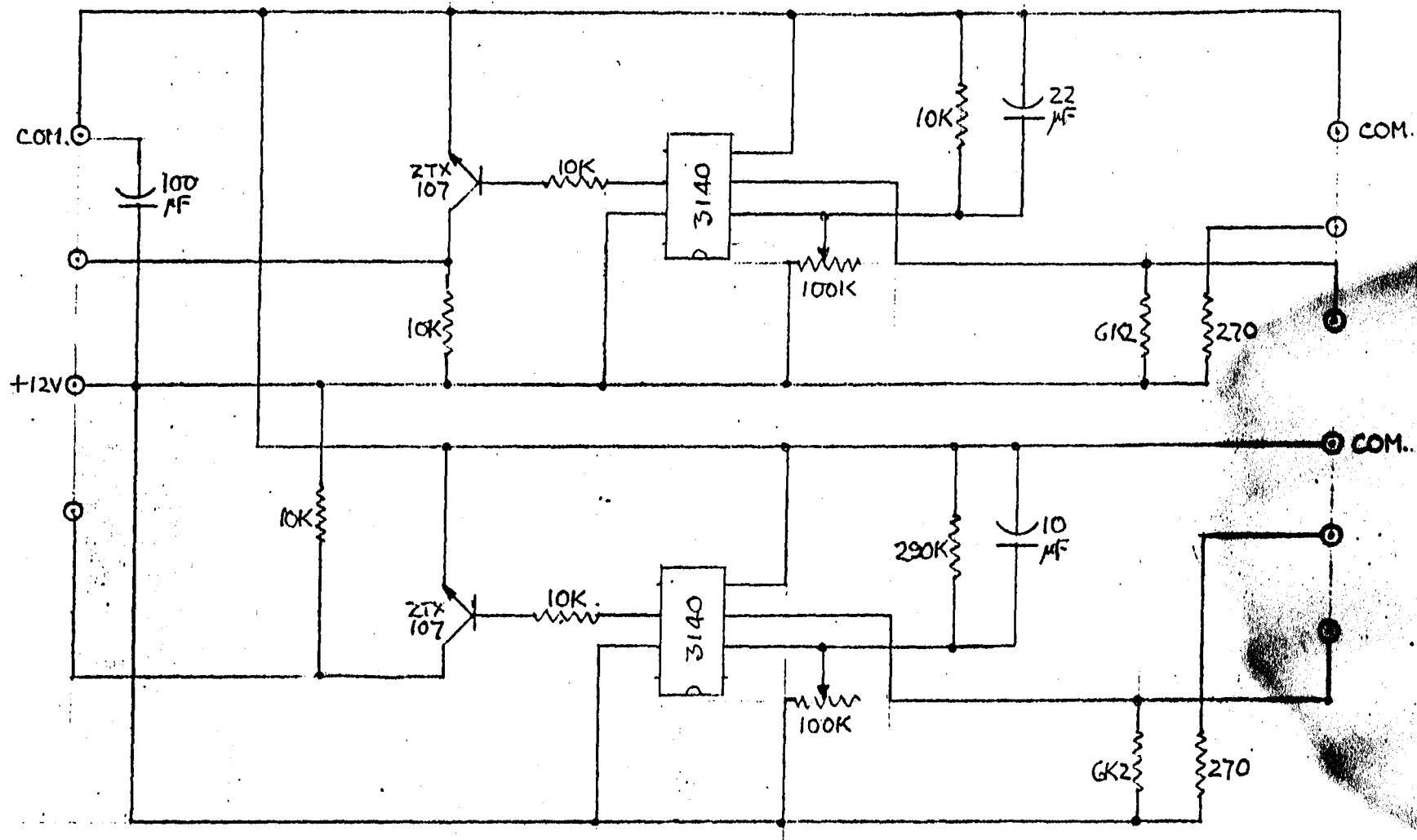

REVISIONS

TITLE

CIRCUIT DIAGRAM FOR SENSOR-PC1607

JOB	
CODE	
DRN.	J.P.
CKD.	
DATE	14. 2. 83



GSM ELECTRICAL CONTROLS LTD.
 VICTORIA WORKS,
 QUEENS MILL ROAD,
 HUDDERSFIELD.
 W. YORKS. HD1 3PJ
 PHONE 0484 35101/2

DRG. No.

S 1666

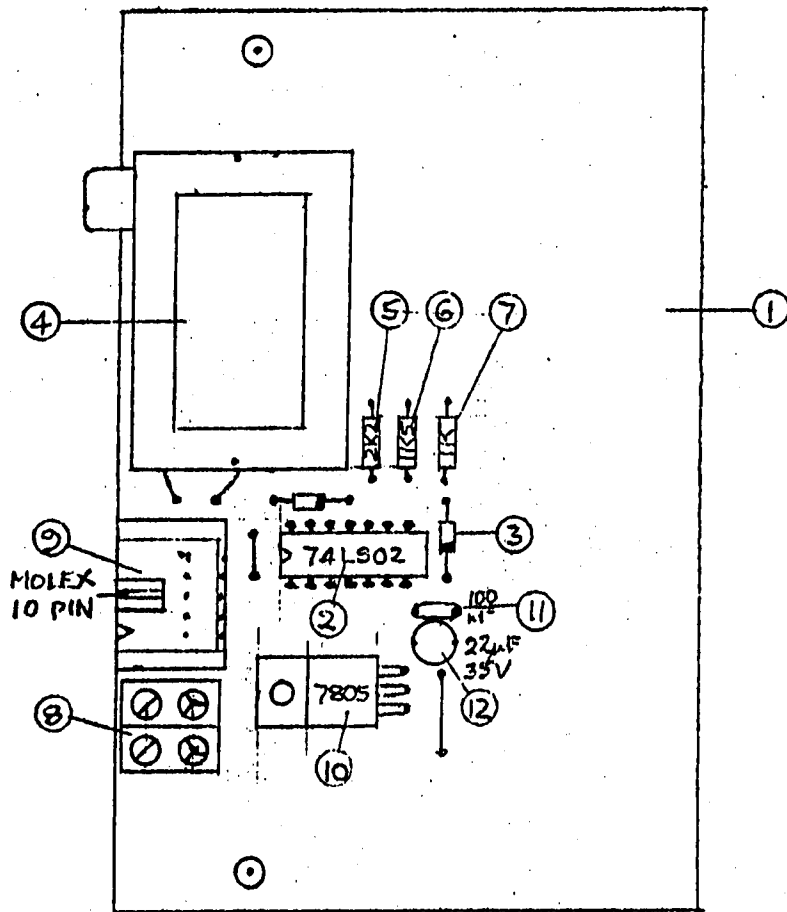

ITEM NR	DESCRIPTION	PART NR	QTY	REMARKS
1	P.C. BOARD.	PC1626	1	
2	N74LS02N.	91C46	1	
3	BAX1301 DIODE	SDD20	2	
4	UM1111 E.36 MODULATOR.	GH197	1	
5	2K2. 1/4W. RES.	XR.222	1	
6	1K5. " "	XR152	1	
7	1K. " "	XR102	1	
8	3WAY TERM. BLOCK	TS197	1	
9	10WAY RIBBON CABLE CONNECTOR	TS212	1	
10	7805 REGULATOR	61C26	1	
11	0.1µF CAPACITOR	C144	1	
12	22µF 35V " "	C.225	1	

REVISIONS

TITLE

COMPONENT LAYOUT OF
MODULATOR BOARD-PC1626

JOB
CODE

DRN.

CKD.

DATE

S.F.B.

17. 3. 83



GSM ELECTRICAL CONTROLS LTD.

VICTORIA WORKS,
QUEENS MILL ROAD,
HUDDERSFIELD.
W. YORKS. HD1 3PJ
PHONE 0484 35101/2

DRG. No.

S 1668

CABLE CONNECTIONS
CASSETTE END
CON. 8, 10, 14, 19 & 20 CUT-SHORT

CABLE CONNECTIONS
TIO 'A' END
NUMBER TO NUMBER

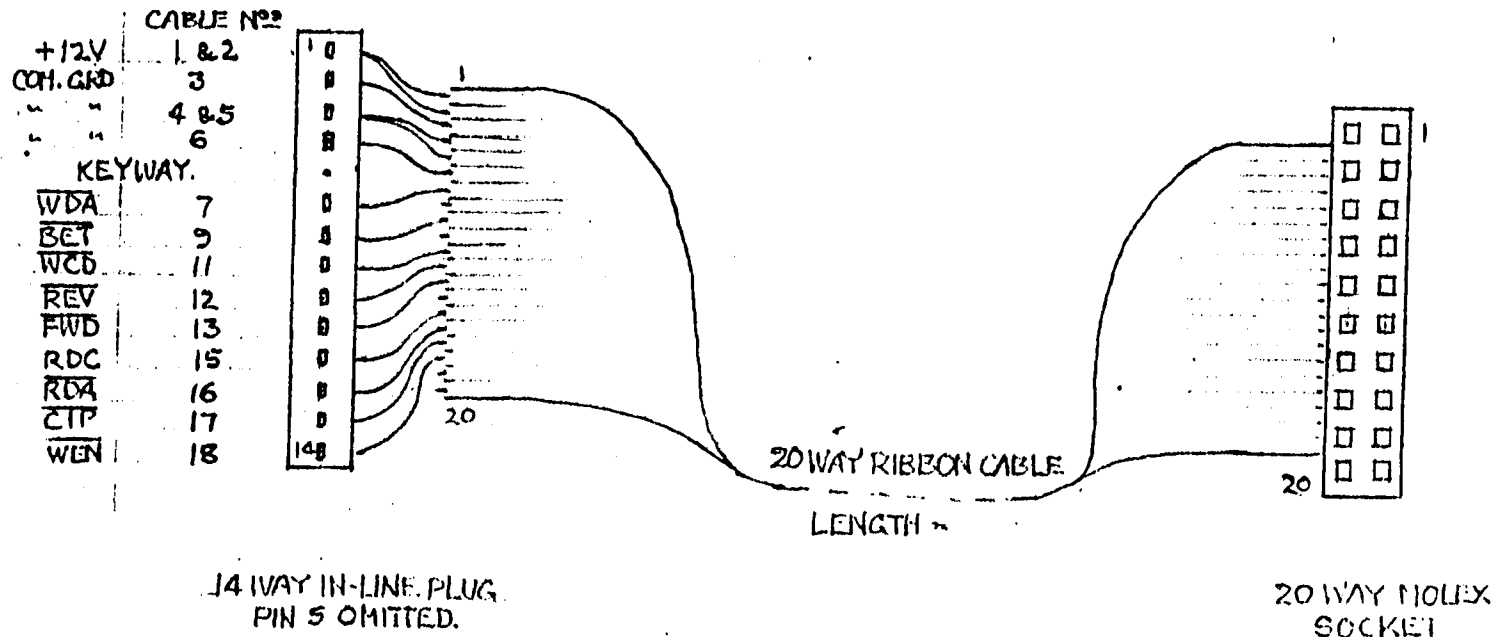

REVISIONS

TITLE
DATA CASSETTE RIBBON CABLE TO TIO 'A' MODULE
CONNECTION DETAILS

JOB	
CODE	
DRN.	<i>L.C.</i>
CKD.	
DATE	21. 4. 83



GSM ELECTRICAL CONTROLS LTD.
VICTORIA WORKS,
QUEENS MILL ROAD,
HUDDERSFIELD.
W. YORKS. HD1 3PJ
PHONE 0484 35101/2

DRG. No.

S1682

MK 3

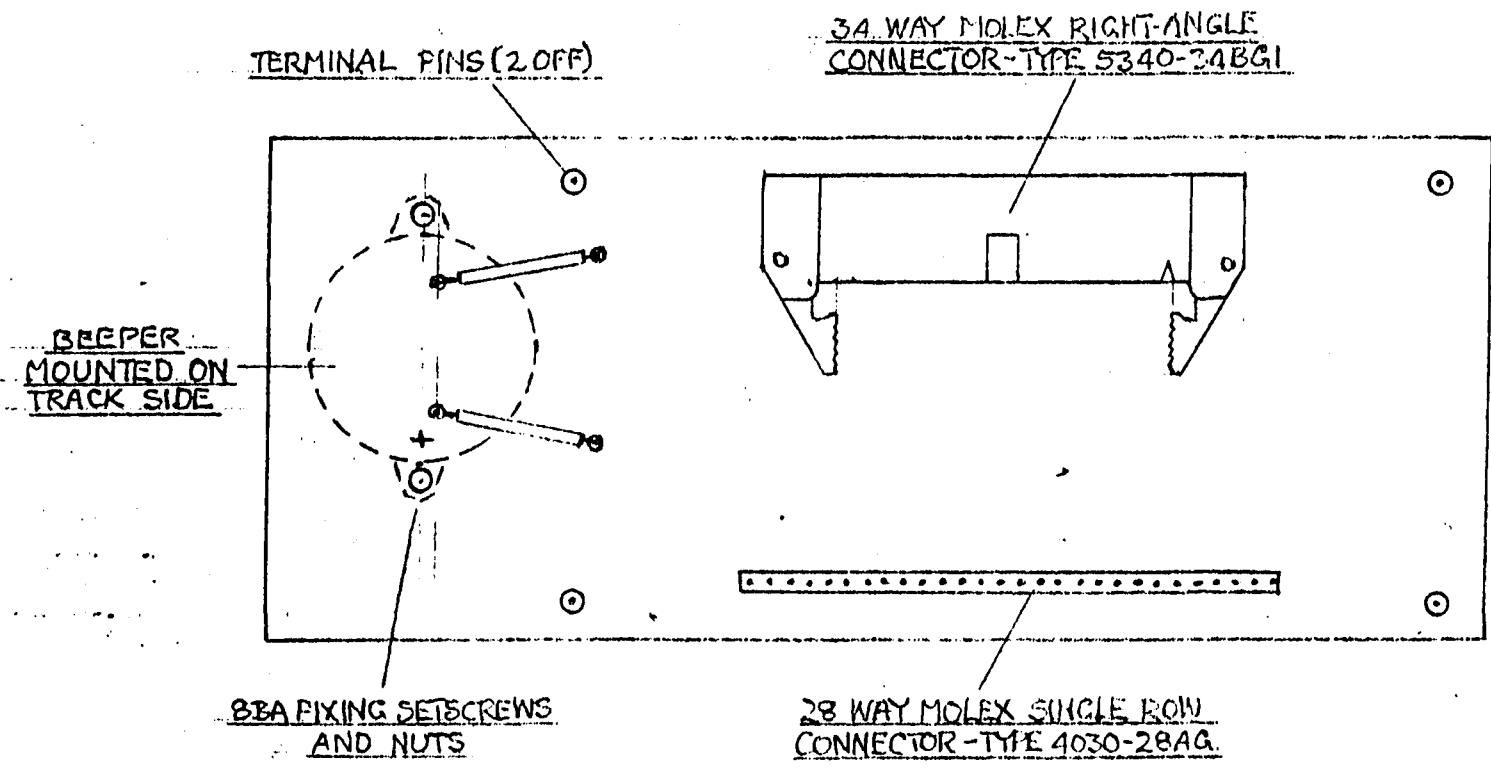

REVISIONS	JOB
TITLE	CODE
COMPONENT LAYOUT FOR PC1693-SYNTELECT MKII. KEYBOARD CONNECTOR & BLEEPER	DRN. <i>J.B.</i>
	CKD.
	DATE 4. 7. 83

GSM ELECTRICAL CONTROLS LTD.
 VICTORIA WORKS,
 QUEENS MILL ROAD,
 HUDDERSFIELD,
 W. YORKS. HD1 3PJ
 PHONE 0484 35101/2

DRG. No.
S 1698

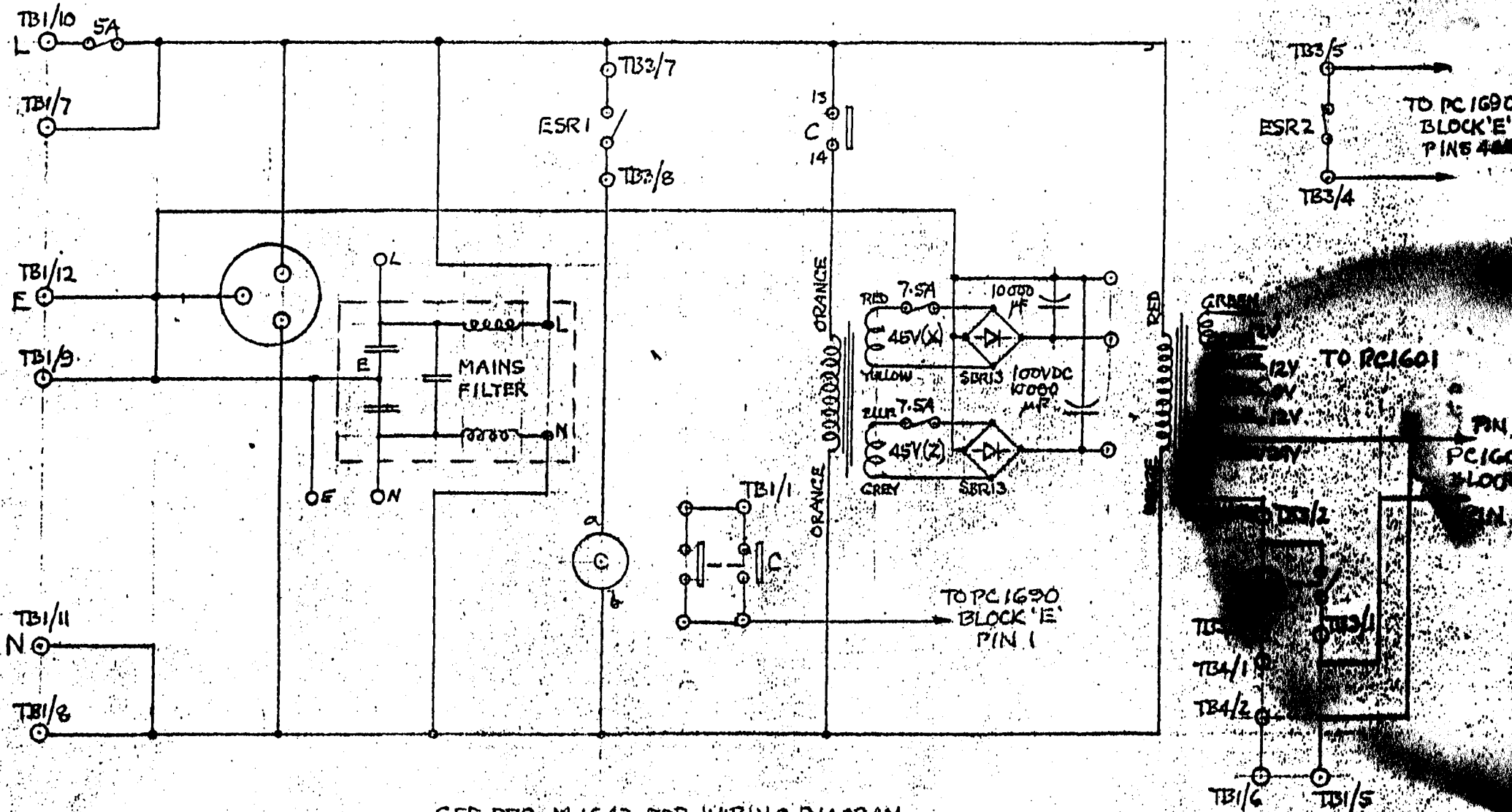

SEE DRG. M.1642 FOR WIRING DIAGRAM.

REVISIONS	
TITLE	CIRCUIT DIAGRAM OF ORAC POWER SUPPLY

JOB	
CODE	
DRN.	J.P.S.
CKD.	
DATE	24.11.82

GSM ELECTRICAL CONTROLS LTD.
 VICTORIA WORKS,
 QUEENS MILL ROAD,
 HUDDERSFIELD,
 W. YORKS. HD1 3PJ
 PHONE 0484 35101/2

DRG. No.
S1719

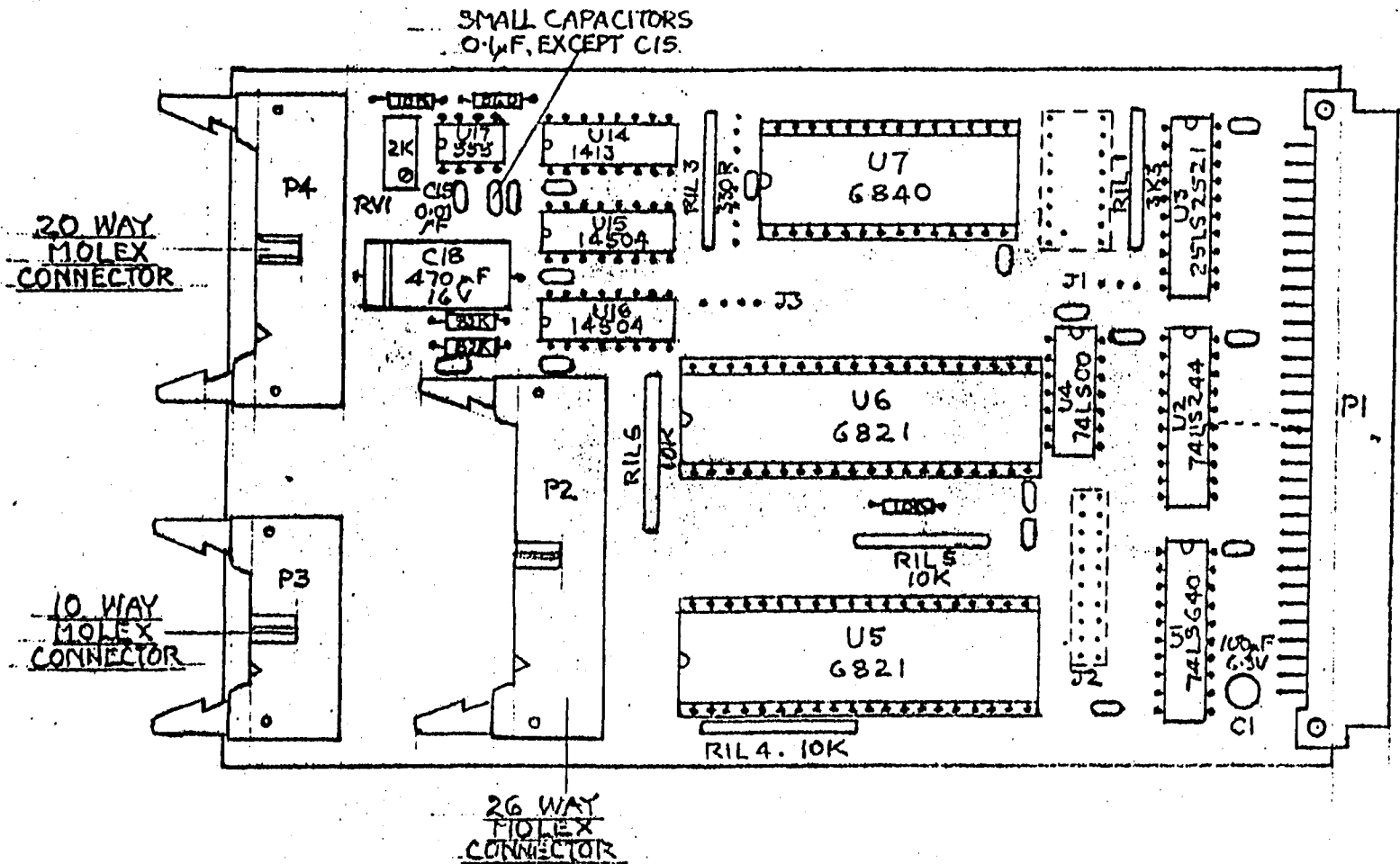

Printed in Great Britain

REVISIONS	JOB	 GSM ELECTRICAL CONTROLS LTD. VICTORIA WORKS, QUEENS MILL ROAD, HUDDERSFIELD, W. YORKS. HD1 3PJ PHONE 0484 35101/2
TITLE	CODE	
COMPONENT LAYOUT FOR T10-A TIMER MODULE.	DRN. <i>L.R.</i>	
	CKD.	
	DATE 30.8.87	

DRG. No.
S1737

ALL SMALL CAPACITORS 0.1µF

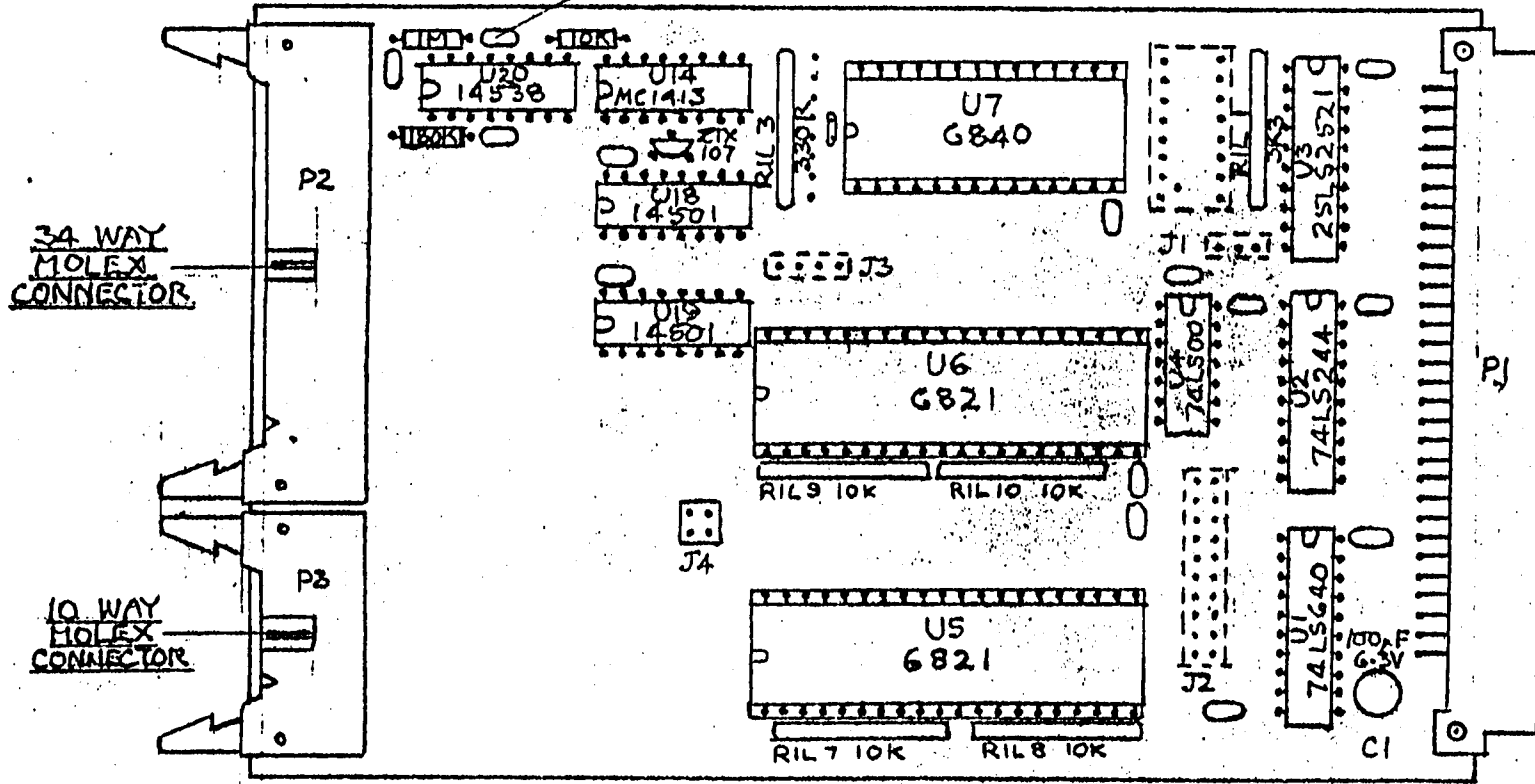

REVISIONS

TITLE

COMPONENT LAYOUT FOR
TIO-B TIMER MODULE

JOB	
CODE	
DRN.	J.F.B.
CKD.	
DATE	30. 8. 83



GSM ELECTRICAL CONTROLS LTD,
VICTORIA WORKS,
QUEENS MILL ROAD,
HUDDERSFIELD,
W. YORKS. HD1 3PJ
PHONE 0484 35101/2

DRG. No.

S 1738

Remove existing choke and replace with 0.75mm² red cable

Melt a 2.5mm² dia. slot to accommodate capacitor lead

Sleeve capacitor lead with 1mm red rubber sleeving and solder to cable as shown

Solder cable to capacitor lead and sleeve with 4.8mm yellow heat shrink sleeving.

18½" 0.75mm² Black cable

REVISIONS

TITLE

AUDIO CASSETTE SUPPLY CABLE

JOB	
CODE	
DRN.	A.C.H
CKD.	



GSM ELECTRICAL CONTROLS LTD.
VICTORIA WORKS,
QUEENS MILL ROAD,
HUDDERSFIELD,
W YORKS WF1 3DR

DRG. No.

S1741

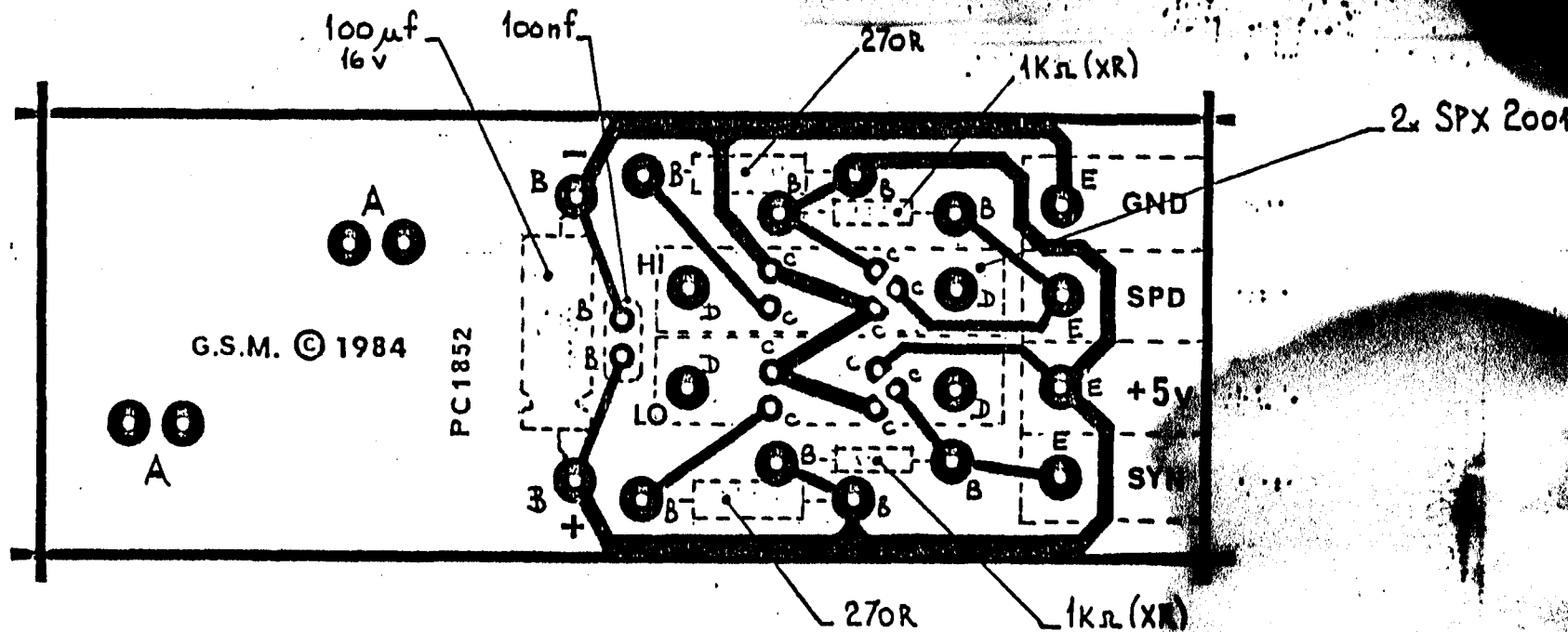

HOLE REF.	Nº OFF	DRILLING DETAILS.
A	2	DRILL 2x N° 26 THEN SLOT.
B	12	DRILL N° 60
C	10	PILOT N° 70 THEN N° 60
D	4	DRILL N° 30
E	4	DRILL N° 54

FIXING DETAILS

- "HIGH" OPTO:- 2 OFF M3 x 12MM C.H. SCREWS WITH 4 BA NUTS AS SPACERS. SECURED WITH PLASTIC NUTS.
- "LOW" OPTO:- 2 OFF M3 x 10MM C.H. SCREWS & PLASTIC NUTS.
- P.C.B.:- FIT TO BRACKET WITH 2 OFF 4 BA SCREWS AND SHAKE PROOF WASHERS.

REVISIONS REDRAWN FROM S1754 - EXTRA COMPONENTS FITTED.

TITLE DRILLING DETAILS ETC FOR P.C.1852 MK III OPTO-SENSOR
P.C.B. FOR SYNTELECT.

JOB
 CODE
 DRN. *P.R.J.*
 CKD.
 DATE 21.2.84

GSM-SYNTTEL LTD.
 VICTORIA WORKS,
 QUEENS MILL ROAD,
 HUDDERSFIELD,
 W. YORKS. HD1 3PB
 Phone: 0484 38101/8

DRG. No.

S1853